

FOUR CLOT

Coagulation Analyser

**User Manual Version
With Incubator 1.005A**



ROBONIK (INDIA) PVT. LTD.

Plot No.: A-374, TTC, MIDC Industrial Area,
Mahape, Navi Mumbai – 400 710. (INDIA)

Tel.: +91 (22) – 67829700, Fax: +91 (22) – 67829701

Email-sales@robonikindia.com

Website-www.robonik.in

TABLE OF CONTENTS

1. GENERAL INFORMATION	4
1.1. <i>Warranty Information:</i>	4
1.2. <i>Technical Service:</i>	4
1.3. <i>Disposal Instruction:</i>	4
1.4. <i>Contacts:</i>	4
2. GENERAL SAFETY WARNINGS	5
2.1. <i>Danger – warnings symbols:</i>	5
2.2. <i>Use of the Instrument:</i>	6
3. INTRODUCTION	7
3.1. <i>DESCRIPTION</i>	7
3.2. <i>Special Features</i>	7
3.3. <i>Technical specification of FOUR CLOT:</i>	8
4. PACKING, TRANSPORT AND STORAGE.....	10
4.1. <i>GENERAL WARNINGS:</i>	10
4.2. <i>PACKING:</i>	10
4.3. <i>INSTRUMENT TRANSPORTATION :</i>	10
4.4. <i>STORAGE OF INSTRUMENT:</i>	10
5. INSTRUMENT DESCRIPTION	11
5.1. <i>Touch Sensitive screen</i>	11
5.2. <i>Perspective View</i>	12
5.3. <i>KEYPAD</i>	13
5.4. <i>Printer</i>	13
6. Installation and start-up instructions.....	14
6.1. <i>Placing the instrument</i>	14
6.2. <i>Power supply</i>	14
6.3. <i>Protective Grounding</i>	14
6.4. <i>Start up Instructions:</i>	14
7. PRECAUTIONS.....	15
8. MAIN MENU.....	16
8.1. <i>TEST OPERATIONS:</i>	16
A) <i>Programming/ADDING a NEW TEST:</i>	16
B) <i>Recalling a Saved TEST:</i>	24
C) <i>Running a Saved TEST (Operating the programmed Tests)</i>	
D) <i>List Tests:</i>	28
8.2. <i>TECHNICAL DIAGNOSIS:</i>	29
8.2.1. <i>Clear Memory</i>	29
8.2.2. <i>Temperature Setting</i>	30
8.2.3. <i>Lamp Amplitude</i>	30
8.2.4. <i>Printer Self Test</i>	31
8.3. <i>UTILITIES SCREEN:</i>	31
8.3.1 <i>To ENTER/CHANGE Date and Time</i>	31
8.3.2. <i>Password Utility:</i>	32
8.3.3. <i>To disable or enable the Printer:</i>	33
8.3.4. <i>To Enter Clinic Name:</i>	33
8.3.5. <i>Lamp: ON</i>	34
8.3.6. <i>Stirrer: ON</i>	34

8.4. QUALITY CONTROL:	35
8.5. View Stored Results/ Print Patient Report:	36
8.6. Serial communication:	37
9. Programming Modes (PHOTOMETRIC)	38
9.1. ABSORBANCE	38
9.2. FIXED TIME	40
9.3. KINETIC	44
9.4. END POINT	48
10. Trouble Shooting:	52
11. Decontamination	53
11.1. Decontamination Procedure	53
11.2. Purpose of Decontamination	53
11.3. General Considerations	53
11.4. Procedure	53
12. SAFETY CLEARANCE CERTIFICATE	54

1. GENERAL INFORMATION

1.1. Warranty Information:

Each Instrument is completely tested and guaranteed for twelve months from delivery. The warranty applies to all the mechanical and electrical parts. It is valid only for proper installation, use, and maintenance in compliance with the instructions given in this manual.

ROBONIK will at its discretion repair or replace parts, which may be found defective in the warranty period. The warranty does not include any responsibility for direct or indirect personal and material damages, caused by improper use or maintenance of the instrument.

Parts that are inherently subject to deterioration are excluded from the warranty. In case of defects due to misuse of the instrument, any travel and man-hour expenses will be charged extra.

1.2. Technical Service:

ROBONIK is always accessible to the customers for any kind of information about installation, use, maintenance, etc. When asking for service, please refer to this manual, and report the data reported on the identification label (serial number).

Only qualified technicians are entitled to fix the instrument; the user, as described in this manual, should carry out ordinary maintenance.

ROBONIK technical service or an authorized service center with specialized technicians, with suitable instrumentation and original spare parts only are always available for extraordinary maintenance (repair), under a yearly maintenance contract or on specific demand.

1.3. Disposal Instruction:

In case of removal or disposal of instrument, following instructions need to be followed

- 1) Do not dispose in municipal waste; follow local regulations for instrument disposal.
- 2) Plastic parts, Electronic PCBs and components can be recycled, so return back the instrument to manufacturer.

1.4. Contacts:

MANUFACTURER:

ROBONIK (INDIA) PVT LTD
A-374, TTC, MIDC Industrial Area,
MAHAPE, NAVI MUMBAI -400710
INDIA

Tel: +91-22-67829700,
Fax: +91-22-67829701

Email: sales@robonikindia.com
Website: www.robonik.in



2. GENERAL SAFETY WARNINGS

2.1. Danger – warnings symbols:

The following symbols are used to inform the user of the safety rules.



This symbol indicates generic danger. It means that, serious damage can occur to the operator if described precautions are not observed.



This symbol indicates HIGH ELECTRIC VOLTAGE. It is dangerous to touch any part having this label. Only qualified operators can access these components, after unplugging the instrument from the Supply.



This symbol indicates that the instrument involves the handling of samples, which can be infected (urine or human serum). In this condition, infection or contamination might occur. Pay attention to the general safety warnings when in presence of such biological substances. Use Protective clothes, gloves and glasses.



This symbol in the user manual indicates that damages to the instrument or erroneous results could occur if the given warnings are not followed.



This symbol indicates a portion, which is particularly important, and should be studied carefully.



This symbol indicates a Protective Earth or Ground terminal.

General Symbols



Symbol for “Manufacturer”



Symbol for “ IN VITRO DIAGNOSTIC MEDICAL DEVICE”

2.2. Use of the Instrument:

The instrument has to be used for the designed purposes under specified conditions, following proper procedures and safety rules, by qualified personnel.

THIS MANUAL CONTAINS INSTRUCTIONS FOR OPERATION BY QUALIFIED PERSONNEL.

- 1) A qualified user has to make sure that environmental condition is suitable, the installation is correct, the use and maintenance are proper, according to the general safety rules as well as to the particular precautions described in the manual. (However, he is not entitled to repair the instrument).
- 2) A qualified technician is entitled to maintain and fix the instrument, according to the instructions given, using the original spare parts. Maintain room temperature and Humidity as specified in the manual.
- 3) The instrument has to be used as described in this manual. If it is not use the protection provided by the instrument may be impaired.
- 4) Alterations to the instrument are prohibited. The user is liable for any improper modification to the instrument, and for the deriving consequences.
- 5) Should the instrument need extraordinary maintenance, contact MANUFACTURER service or authorized service center. Specialized technicians who will be able to repair the instrument using original spare parts will carry out the maintenance.
- 6) This IVD equipment complies with the emission and immunity requirements as per IEC61326 series.



- 7) **Warning:** This equipment has been designed and tested to CISPER11 Class A. In a domestic environment it may cause radio interference, in which case, you may need to take measures to mitigate the interference."

- 8) An advisory that the electromagnetic environment should be evaluated prior to operation of the device.



- 9) **Warning:** Do not use this device in close proximity to sources of strong electromagnetic radiation (e.g. unshielded international RF sources), as these may interfere with the proper operation.

3. INTRODUCTION

3.1. DESCRIPTION

FOURCLOT is a programmable Coagulometer with a sophisticated on board software and user-friendly touch screen. Its versatile and unique software supports most of the calculation required for interpretation of results. It is a reliable, high precision machine. It is intended for in vitro diagnostic use. It has a user-friendly program and capacity of storing the programmed analytical methods and the QC results. It is intended for in vitro diagnostic use.

3.2. Special Features

Coagulation

- Four independent programmable coagulation channels for faster throughput.
- Display on line results of all four channels simultaneously on single screen.
- Sample averaging up to 4 coagulation runs in PT, APTT, TT, Fibrinogen.
- Designed to perform all routine tests such as PT, APTT, TT, Fibrinogen, Factor II, V, VII, IX, X, XI, XII.
- Uniform mixing of Sample & Reagent with magnetic stirrer.
- Reporting of results in second, INR, Ratio and %.
- Automatic sensing of sample/reagent dispensing to start the measurement
- Incubation for 24 positions for samples and reagent.
- Built in printer and option to connect external 80 column printer.
- Low reagent/sample volume for testing
- Multipoint Calibration curve with user entered standard dilution %, in FIB and Factor Assay

Photometer

- Independent channel for Photometric assays
- Multipoint calibration curve with max.7 calibrators for Photometric assays.
- Chromogenic assays antithrombin III (AT-III), protein C (PC), protein S (PS), D-dimer.

Common Features

- Effective temperature regulation system.
- Robust system with built in stabilizer.
- Latest technology with battery back up for 250 tests with QC and more than 2500 results, independent memory for Coagulation and Photometric mode.
- Alpha numeric Patients ID entry.
- Combine report printing for coagulation and photometer test with unique patient ID.
- Robust in built 20 column thermal printer with 384 stationary heads.
- Unique circuitry for long lamp life.
- Human machine interface : Touchpad, Keypad
- Built in Incubator.
- Quality Control with Levy Jennings and standard deviation graphs.
- Access to test by touch of key.

3.3. Technical specification of FOUR CLOT:

Coagulation:

Measuring System	Photometric
Optical measurement	Photodiode
Measurement Volume	150 µl
Sample & reagent mixing	With magnetic stirrer
Dry block incubator Number of cuvette Holders Temperature Timer	24 positions for sample and reagent cuvette incubation. 37 ⁰ c Programmable
Light source	LED/Laser
Analysis mode	PT, APTT, TT, Fibrinogen, Factor assay (Factor II, V, VII, IX, X, XI, XII).
Results displayed in	Seconds, Ratio, INR, Concentration and %

Photometer:

Linear measurement range	0.000 to 3.000 Absorbance Units (A).
Photometric Accuracy	± 2% or 0.007 whichever is higher, from 0 to 1.5 A ± 3% from 1.5 A to 3.0 A
Drift	<0.007 A/hr
Photometric Linearity	2.2 A
Optical measurement	Photodiode
Filters Type of filter Wave Length	Narrow band Interference 405, 630 nm (optional)
Light source	Tungsten Halogen
Warm up Time	90 Sec
Analysis Mode	Photometric mode Absorbance Kinetic End Point Fixed Time

Common:

Human Machine Interface	TOUCH PANEL / KEYPAD
Display	5" Graphic LCD, Negative Blue, STN
Printer	Built – in thermal printer, 20 column
Memory	32 KB Non Volatile RAM with Battery backup
Storage Capacity	Independent capacity of 250 open tests with 30 QC results (Normal and Abnormal controls) and More than 2500 patient results with PID, for Coagulation and Photometer.
External interface	RS232
Power Wattage Voltage	50 Watts 115 – 230 Volts ± 50 / 60 Hz.
Operating position	On horizontal flat, rigid and vibration free surface
Operating conditions Temperature Relative humidity	From + 18 ⁰ c to 35 ⁰ c Up to 85 %
Storage conditions Temperature Relative humidity	From -10 ⁰ c to 60 ⁰ c Up to 85 %
Enclosure	ABS Fire retardant
Size (cms)	34.5 X 30 X 14.7 (l x b x h)
Weight (Approx)	5.4 Kg (Approx.)

4. PACKING, TRANSPORT AND STORAGE

4.1. GENERAL WARNINGS:

Instrument has to be decontaminated before packing for transportation.

4.2. PACKING:

Packaging is needed whenever the instrument is to be transported or shipped by courier or other means.

To pack the instrument follows the instructions below:

- 1) Decontaminate the instrument as explained on decontamination chapter of this manual.
- 2) Put the instrument into the original packaging box. Instrument has to be properly protected by plastic protective material. Put copy of safety clearance certificate (copy of Safety clearance certificate is attached at the end of this manual).
- 3) Mark the package with address, instrument identification and warning labels

4.3. INSTRUMENT TRANSPORTATION:

The transportation of the instrument in unpacked condition must be limited within the room where it is used to avoid damage.

4.4. STORAGE OF INSTRUMENT:

Before storing the instrument for a long period, pack it carefully as described above and store indoors.

Relative humidity has to be less than 85%, and temperature between -10°C and -60°C.

5. INSTRUMENT DESCRIPTION

5.1. Touch Sensitive screen

FOURCLOT provides a Touch sensitive LCD panel and a KEYPAD for easy user interface. The Menus are displayed; the text of the parameter forms the TOUCH ZONE.

Touch screen Layout

For Example: In PT Mode.

Name:	Mode: PT	
ISI index: 1.000		ESC
Normal: N		
MNPT: 0.000		SAVE
%dilution:		
Sample Avg: 4		
QC: N		
Incub. Time: 0		

Above is the generic representation of a Test Screen. The Highlighted zones are TOUCH ZONES, which are active. On touching the "Touch Zone" of a parameter, a sub menu/menu is displayed or the requested action is carried out, and rest of the "Touch Zone" is deactivated.

For Example:- To activate the selection.

- To enter the ISI Index, touch any point in the shaded area "ISI Index" on the LCD screen. On proper selection the analyser responds with blinking of the parameter text and also the TOUCH ZONE and a submenu is displayed.
- To enter Test Name: Touching the "Name" touch zone provides a alphanumeric screen. Enter the Test name by touching the Touch zone of that variable. The selected value blinks and is displayed next to the parameter.

Selection Indicator:

Selected onscreen item is shown in a shaded background. When the screen first displays, the default selection is shown. Pressing a selection either highlights that item or activates it.

5.2. Perspective View

Front View:

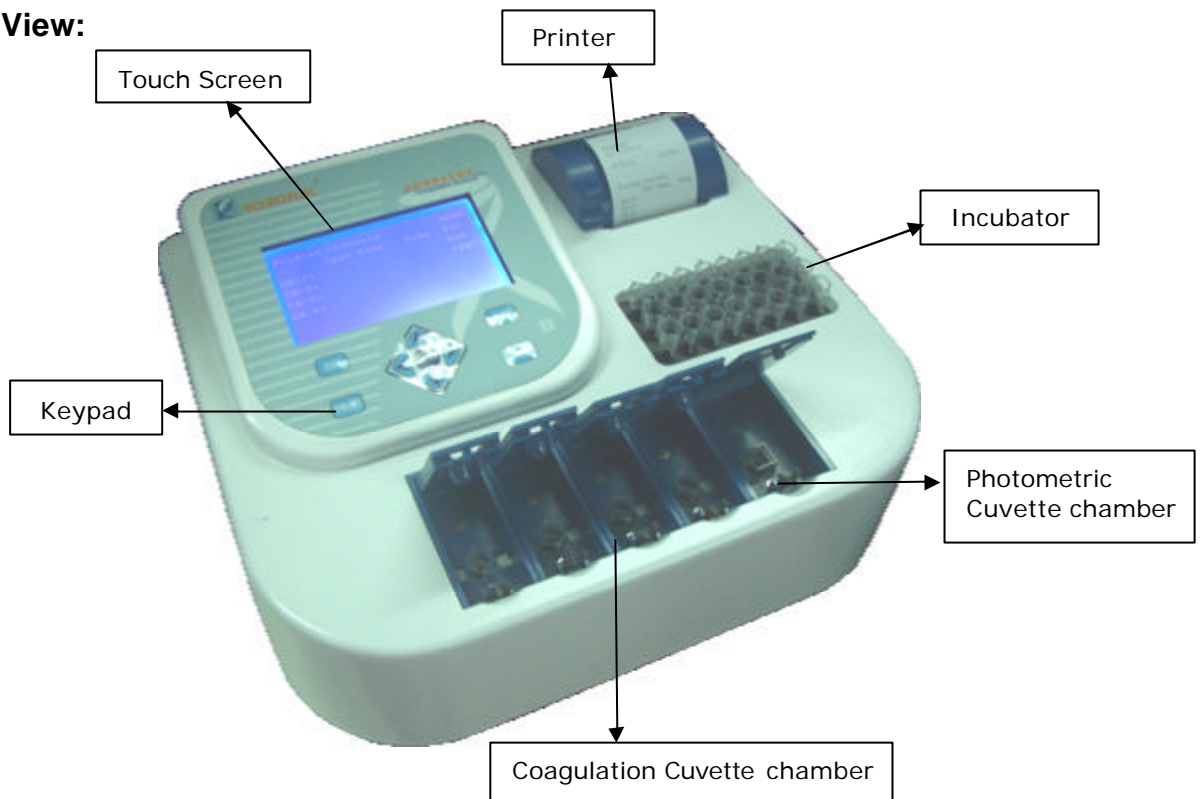

Rear View:

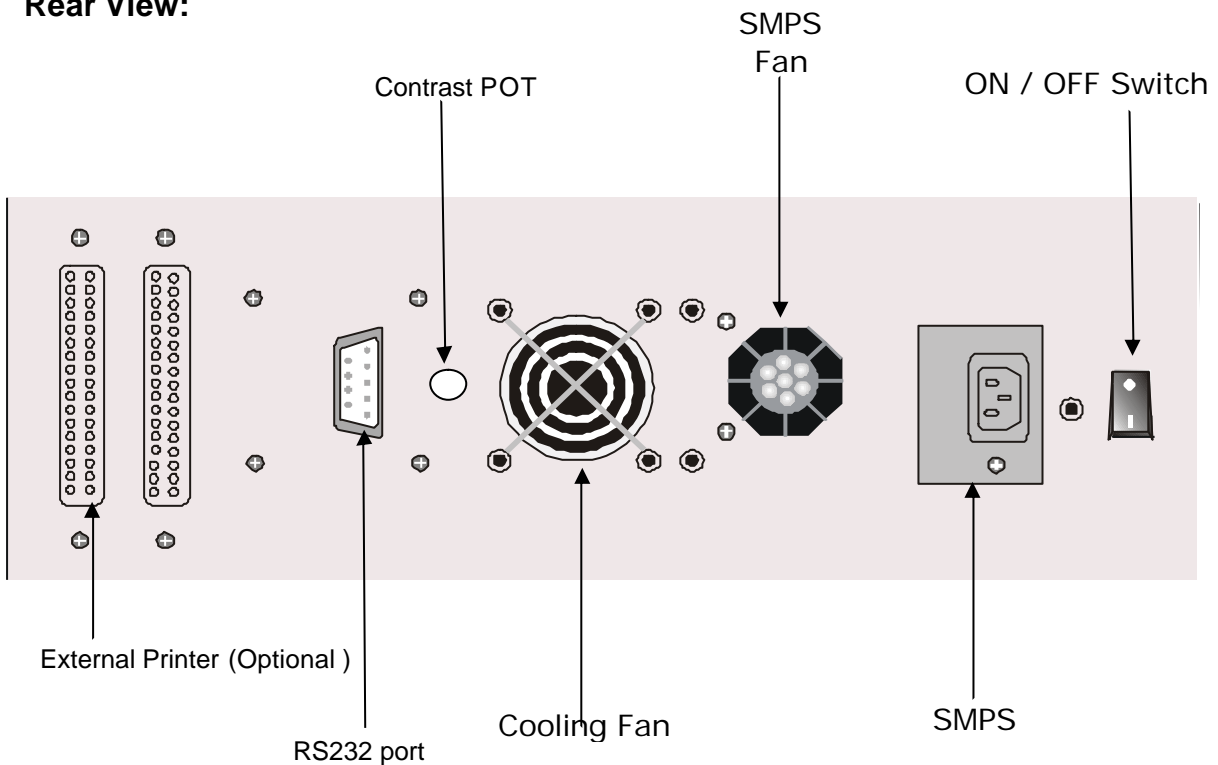

5.3. KEYPAD

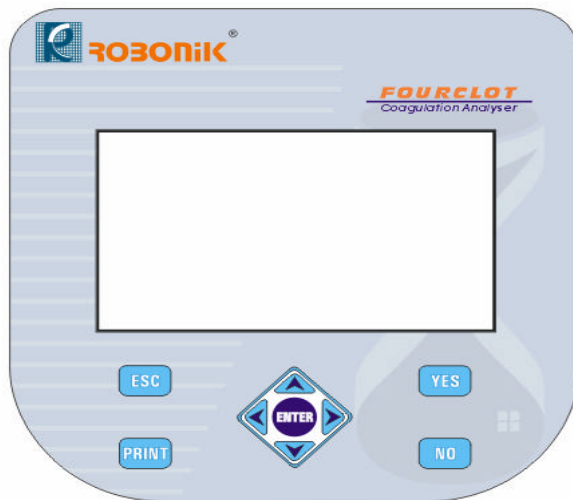

5.4. Printer

A) Internal Printer (Thermal Printer)

FOURCLOT comes with a built in 20 column Thermal Printer. User has to take proper care to handle this delicate instrument.



TIPS FOR CAREFUL USAGE OF PRINTER

- 1) Do not pull the paper when loaded.
- 2) Lift the paper lever carefully and load the paper.
- 3) Keep the instrument clean and dust free.

FOURCLOT gives line feed automatically wherever it is necessary for clear reading like

- a. While powering on
- b. In between character lines

(Note: User may operate the instrument by disabling the printer from the utilities menu.)

✓ **How to insert the paper**

Insert the thermal paper roll by placing the sensitive side facing down. The sensitive paper side is recognizable by its smoother face.

Before inserting the paper

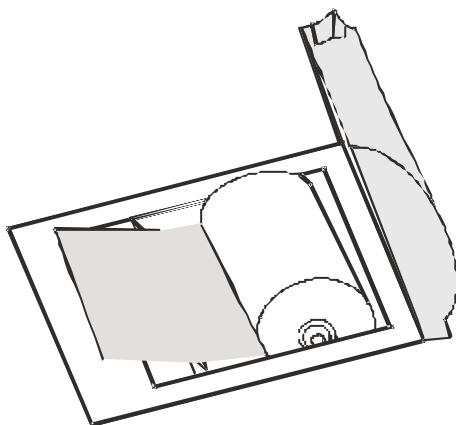

After inserting the paper

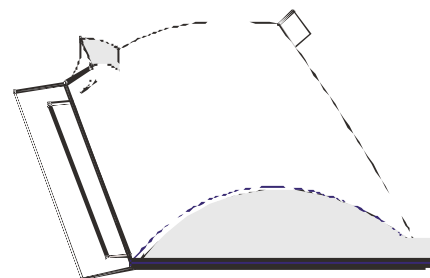

B) External Printer (Optional)

Switch off the analyzer before connecting the printer. Disconnect the small cable from the external printer port (Ref Diagram in 5.3) provided on the rear of analyzer. User can then connect the external printer using the standard communication cable to external printer port.

(Note : If an external printer is connected then the internal printer is disabled.)

6. Installation and start-up instructions

While installing and setting up the instrument, the safety warnings and general precautions described in section 7 must be observed.

6.1. Placing the instrument

Place the instrument on a flat working surface or bench top capable of supporting the weight of the instrument. A clearance of at least 3 inches around the instrument is required to assure optimal ventilation. Room temperature should be between 18°C and 35 °C with a relative humidity below 85%. Protect it from direct sunshine and maintain the instrument in a clean, relatively dust free environment to ensure maximum performance.

6.2. Power supply

Once the instrument has been placed, plug it into a power source by using the locally available approved plug-in cable. Power cord should be CE, CSA and UL marked
Voltage : 115 - 230 Volts ± 10%, 60- 50 Hz

6.3. Protective Grounding

Warning: Make sure that electrical power source is properly grounded.



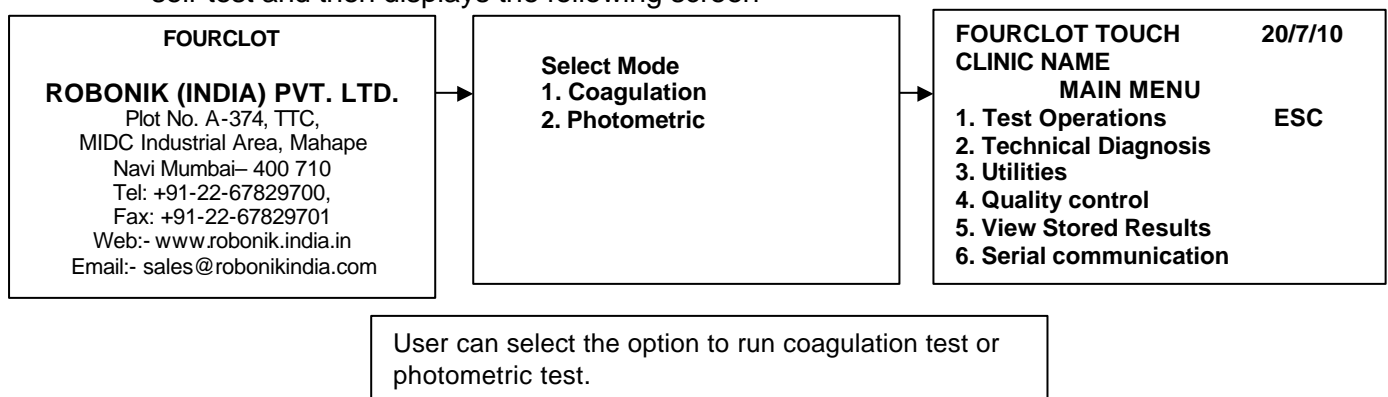

6.4. Start up Instructions:

- 1) Switch on the instrument.
- 2) The instrument initializes all the parameters internally, and carries out a power on self-test and then displays the following screen



- 1) If a printer is enabled, Model Name ,Version Number ,Clinic name / Serial Number, Current time and date will be printed .(Note: If a printer is not enabled, "Disable printer" message is displayed. Touch YES to disable or NO to proceed. Refer for Printer settings)
- 2) Once initialization is over, a lamp located within the instrument will glow. This lamp requires 90 seconds for stabilization.
- 3) After the instrument completes the above steps, a TEST MENU SCREEN / MAIN MENU Screen appears.
- 4) The instrument is now in IDLE mode, and ready for use.

7. PRECAUTIONS

- ❖ Keep the place dry and clean.
- ❖ Check all the grounding wires properly.
-  ❖ Repeat the readings, if Absorbance is more than 2.0 A.
-  ❖ Use original Packing for transportation.
- ❖ Use clean Cuvettes. Check the blank absorbance of the cuvette at regular intervals.
- ❖ Check the temperature of cuvette block at regular intervals.
-  ❖ Check the linearity of the instrument at regular intervals using standards.
- ❖ Do not take any reading when the lid is open.
- ❖ Incubate the cuvettes at set temperature for at least 10 minutes before using.
- ❖ Incubate the reagents at set temperature for at least 10 minutes before using.
-  ❖ Do not use any sharp objects on the Touch Screen. Always use the STYLUS provided to operate the touch panel.

8. MAIN MENU

8.1. TEST OPERATIONS:

A) Programming/ADDING a NEW TEST:

When the unit is first turned on, Mode selection screen is displayed.

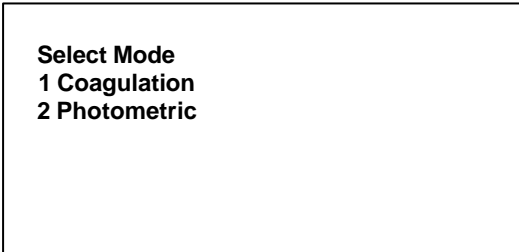

To add and Run coagulation test select **1. Coagulation**. Main Menu Screen appears on the display.

✓ **Main Menu screen**

Main Menu screen consist of Menus as shown below

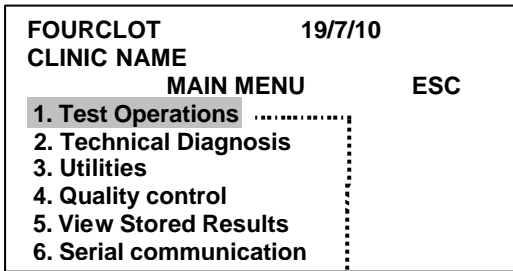

Test Operations screen

Select Menu "Test Operations"

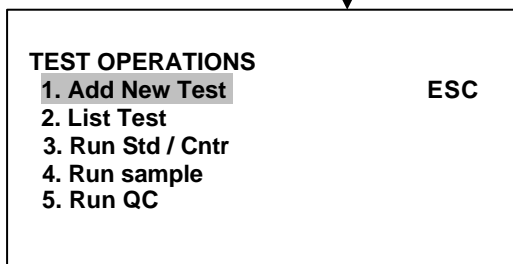

Select Menu "Add New Test"

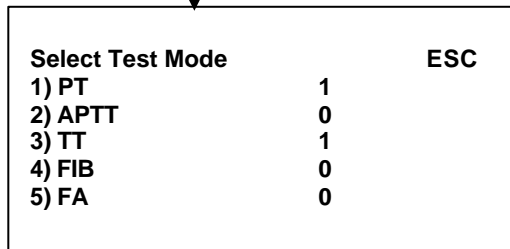

On Select Test Mode screen all the test modes along with the no. of test entered are displayed
Select test mode in which test is to be entered

Coagulation consists of five different modes. They are as follows-

1. PT mode
2. APTT mode
3. TT mode
4. FIB mode
5. FA mode

Let us see how to create a New Test in each mode.

1. PT mode

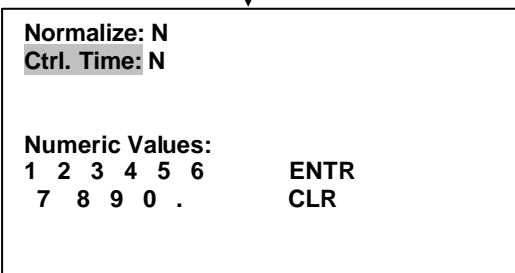
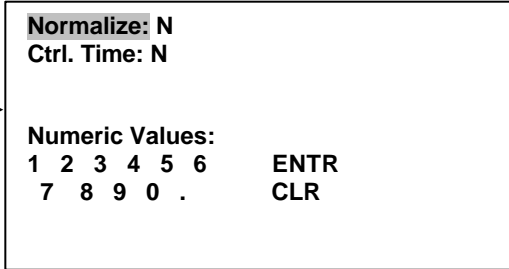
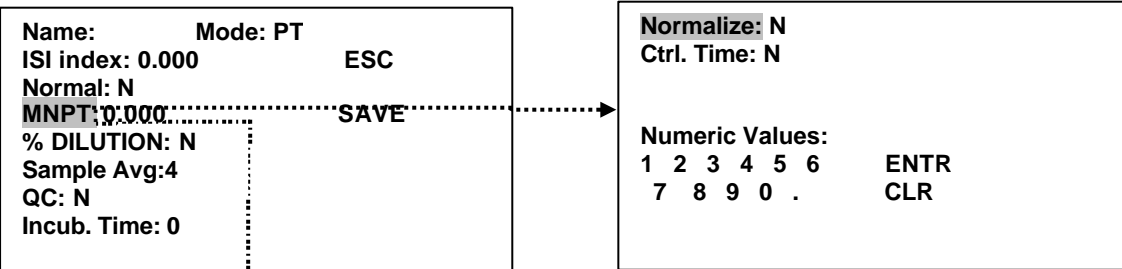
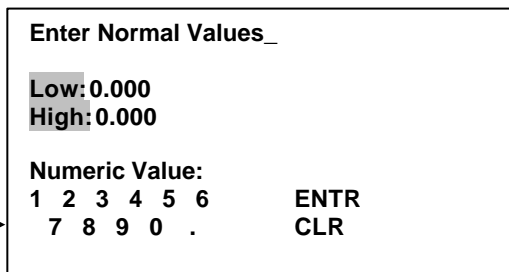
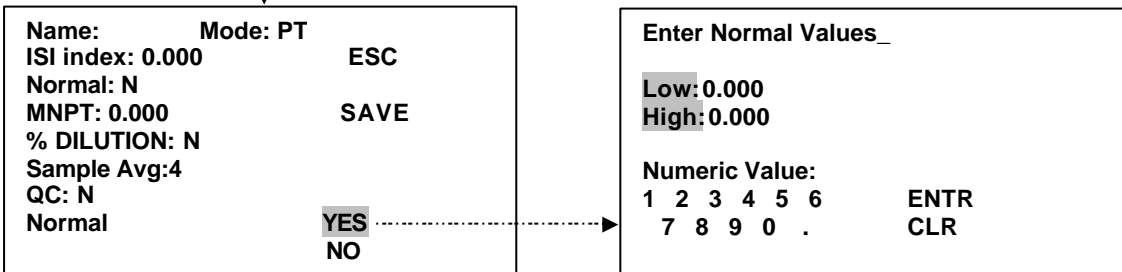
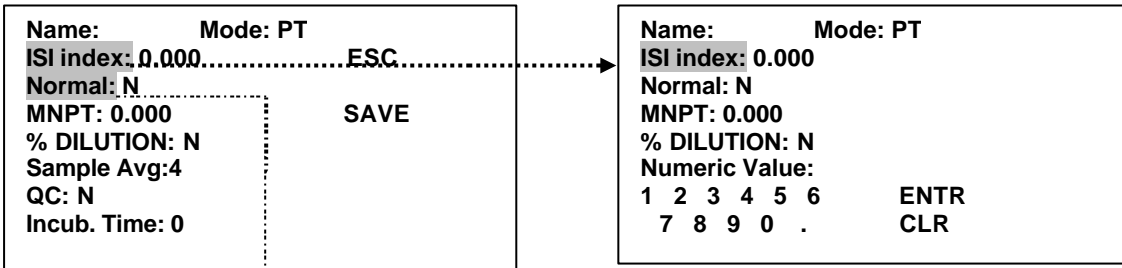
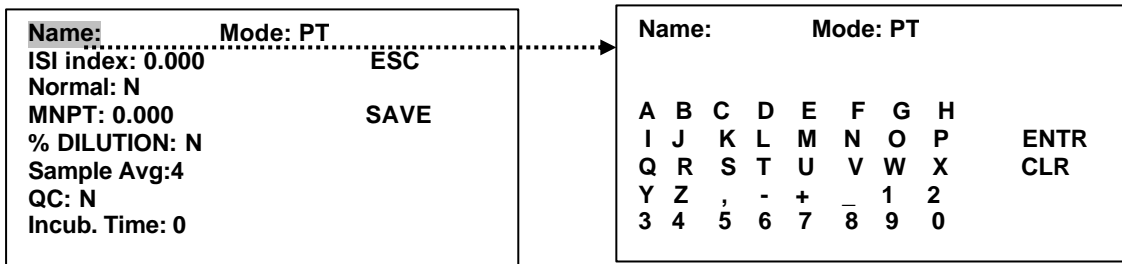

Select "Normalize" if you want to run the standards in PT mode.

Select "Ctrl. Time" if you directly want to run the samples in PT mode.

Name: Mode: PT
 ISI index: 0.000 ESC
 Normal: N
 MNPT: 0.000SAVE
 % DILUTION: N
 Sample Avg: 4
 QC: N
 Incub. Time: 0

Name: Mode: PT
 ISI index: 0.000 ESC
 Normal: N
 MNPT: 0.000 SAVE
 % DILUTION: N
 Sample Avg: 4
 QC: N
 % DILUTION YES
 NO

No. of Dil: 2
 Concen Time
 0.000 0.000
 0.000 0.000
 Numeric Value:
 1 2 3 4 5 6 ENTR
 7 8 9 0 . CLR

No. of Dil: 2
 Concen Time
 0.000 0.000
 0.000 0.000
 Numeric Value:
 1 2 3 4 5 6 ENTR
 7 8 9 0 . CLR

In this screen you have to enter the concentration value & the time related to it.

Enter the Number of Dilutions. Here, Min. number of dilution= 2 and Max. number of dilution=6

Name: Mode: PT
 ISI index: 0.000 ESC
 Normal: N
 MNPT: 0.000 SAVE
 % DILUTION: N
 Sample Avg: 4
 QC: N
 Incub. Time: 0

QCNormal Values_
 QCNH: 0.000 ESC
 QCNL: 0.000
 QCAbnormal Values_
 QCABH: 0.000
 QCABL: 0.000

Name: Mode: PT
 ISI index: 0.000
 Normal: N
 MNPT: 0.000
 % DILUTION: N
 Numeric Values:
 1 2 3 4 5 6 ENTR
 7 8 9 0 . CLR

QCNormal Values_
 QCNH: 0.000
 QCNL: 0.000
 QCAbnormal Values_
 QCABH: 0.000
 Numeric Value:
 1 2 3 4 5 6 ENTR
 7 8 9 0 . CLR

From this screen you can enter the "Sample Avg" values. Max Samp Avg=4

In this screen you can enter both QCNormal (H /L) as well as QCAbnormal (H /L) values.

Name: Mode: PT
 ISI index: 0.000 ESC
 Normal: N
 MNPT: 0.000 SAVE
 % DILUTION: N
 Sample Avg: 4
 QC: N
 Incub. Time: 0

Name: Mode: PT
 ISI index: 0.000
 Normal: N
 MNPT: 0.000
 % DILUTION: N
 Numeric Values:
 1 2 3 4 5 6 ENTR
 7 8 9 0 . CLR

From this screen you can enter the Incubation Time in seconds.

2. APTT mode

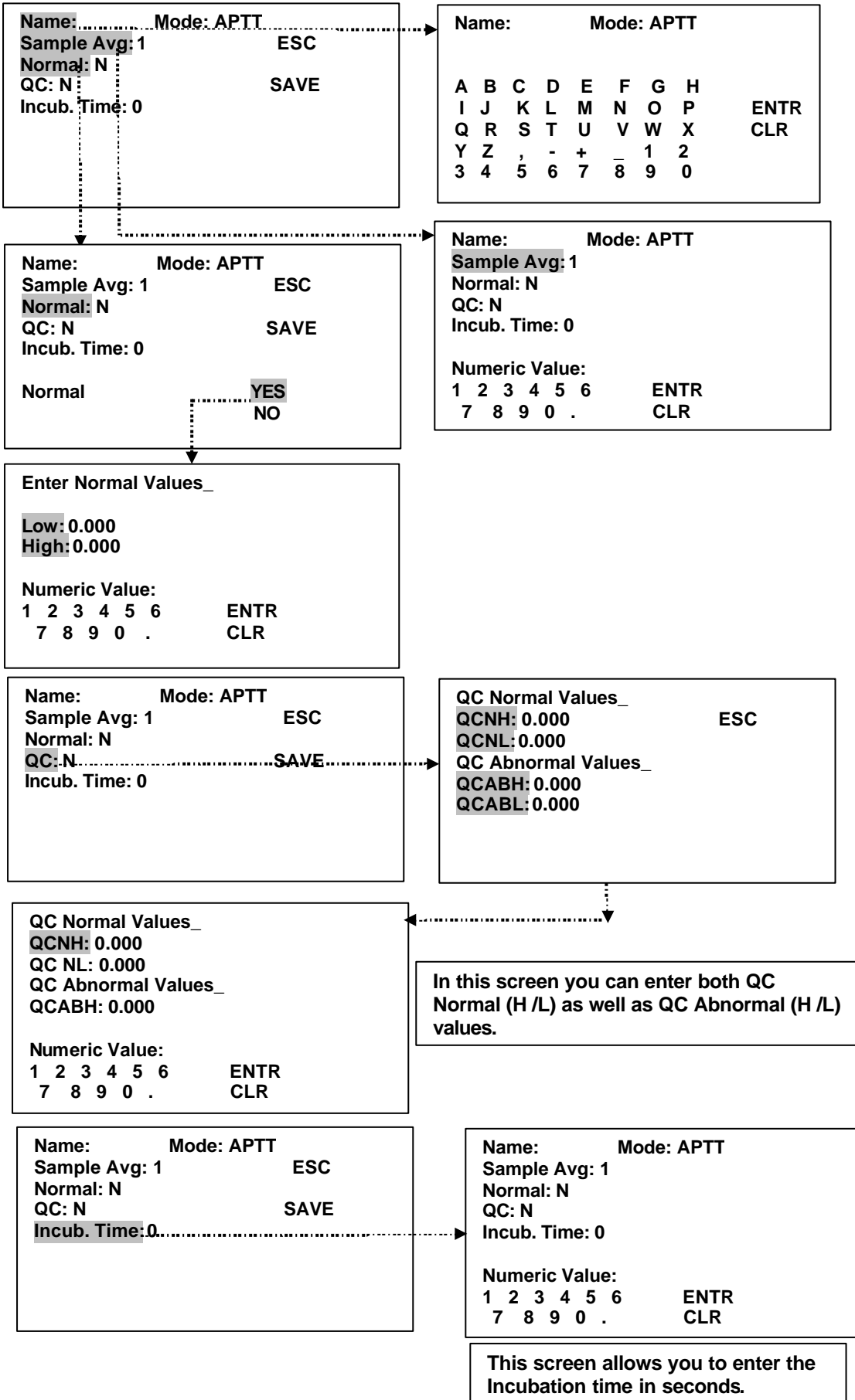

3. TT mode

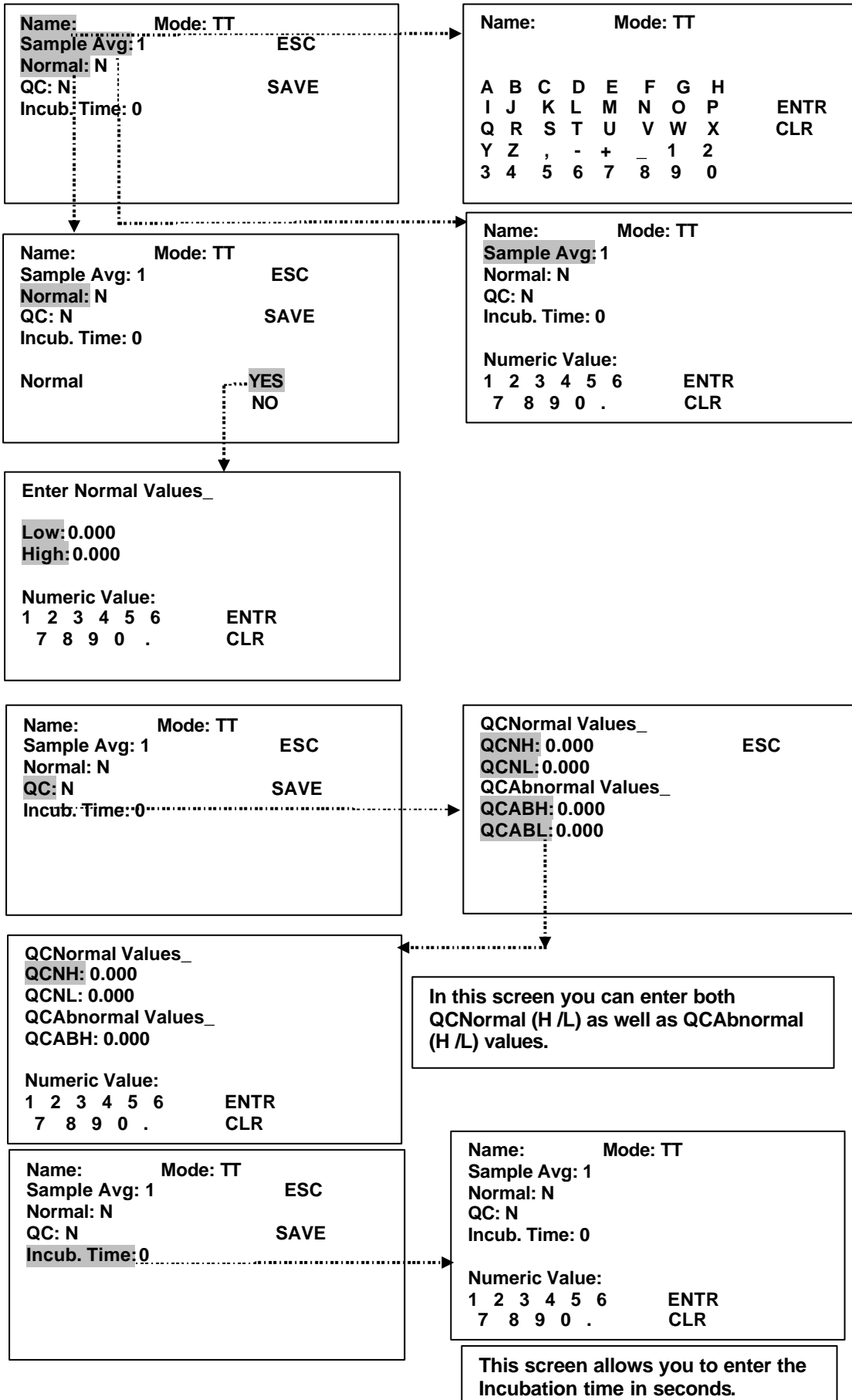

4. FIB mode

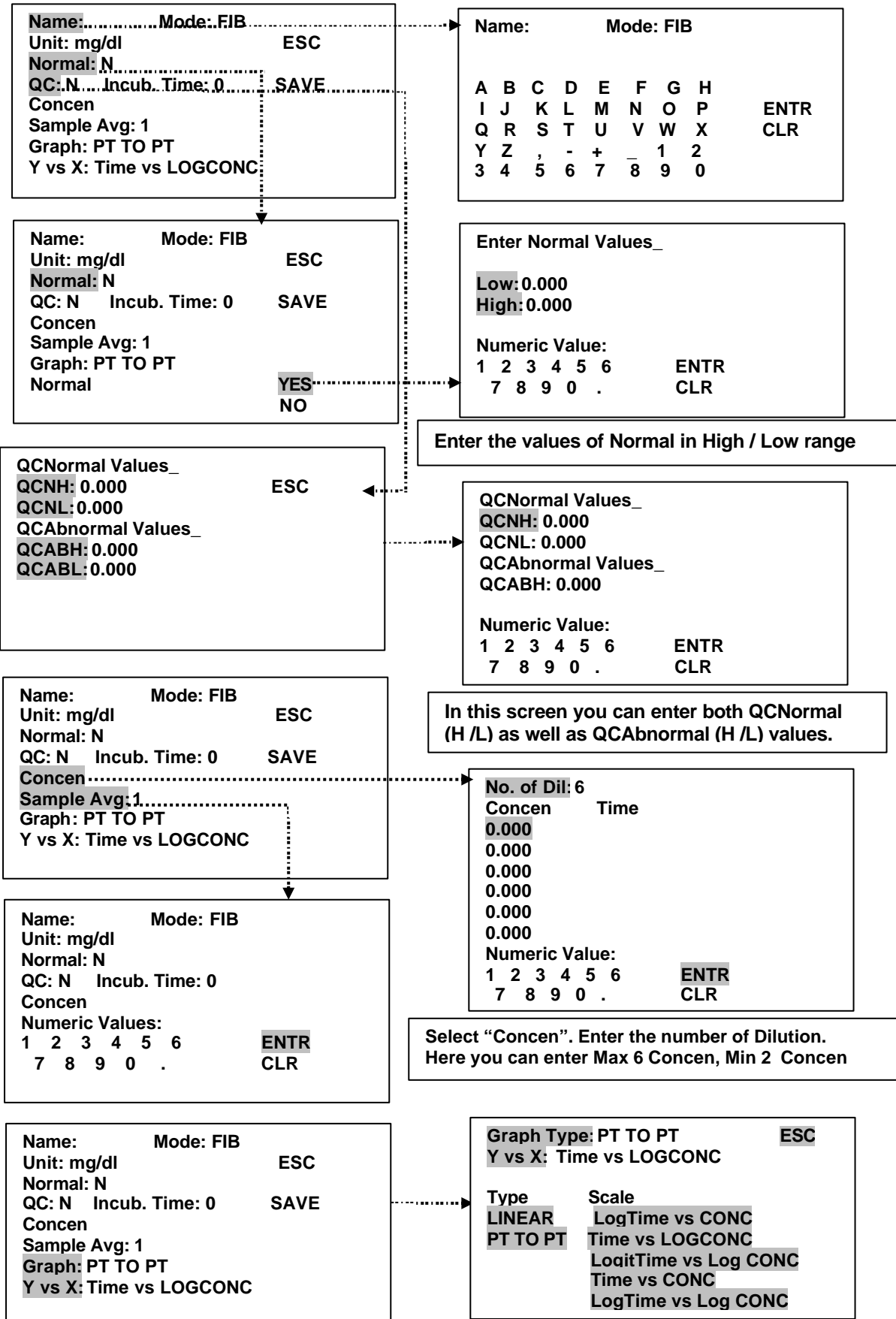

(Note: The UNIT in FIB mode is fixed)

Name: Mode: FIB
 Unit: mg/dl ESC
 Normal: N
 QC: N Incub. Time: 0.....SAVE.....
 Concen
 Sample Avg: 1
 Graph: PT TO PT
 Y vs X: Time vs LOGCONC

Name: Mode: FIB
 Unit: mg/dl
 Normal: N
 QC: N Incub. Time: 0
 Concen
 Numeric Values:
 1 2 3 4 5 6 ENTR
 7 8 9 0 . CLR

This screen allows you to enter the Incubation time in seconds.

5. FA mode

Name:.....Mode: FA.....
 PT: ESC
 APTT:
 QC: N Incub. Time: 0 SAVE
 Concen
 Normal: N
 Graph: LINEAR
 Y vs X: LogTime vs LogCONC

Name: Mode: FIB

 A B C D E F G H
 I J K L M N O P ENTR
 Q R S T U V W X CLR
 Y Z , - + _ 1 2
 3 4 5 6 7 8 9 0

Name: Mode: FA
 PT: ESC
 APTT:
 QC: N Incub. Time: 0 SAVE
 Concen
 Normal: N
 Graph: LINEAR
 Y vs X: LogTime vs LogCONC

FA_II
 FA_V
 FA_VII
 FA_X

FA_VIII
 FA_IX
 FA_XI
 FA_XII

Name: Mode: FA
 PT: FA_V ESC
 APTT:
 QC: N Incub. Time: 0 SAVE
 Concen
 Normal: N
 Graph: LINEAR
 Y vs X: LogTime vs LogCONC

Name: Mode: FA
 PT: ESC
 APTT: FA_XI
 QC: N Incub. Time: 0 SAVE
 Concen
 Normal: N
 Graph: LINEAR
 Y vs X: LogTime vs LogCONC

Name: Mode: FA
 PT: ESC
 APTT: FA_XI
 QC: N Incub. Time: 0 SAVE
 Concen
 Normal: N
 Graph: LINEAR
 Y vs X: LogTime vs LogCONC

QCNormal Values_
 QCNH: 0.000 ESC
 QCNL: 0.000
 QCAbnormal Values_
 QCABH: 0.000
 QCABL: 0.000

No. of Dil: 6
 Concen Time
 0.000
 0.000
 0.000
 0.000
 0.000
 Numeric Value:
 1 2 3 4 5 6 ENTR
 7 8 9 0 . CLR

QCNormal Values_
 QCNH: 0.000
 QCNL: 0.000
 QCAbnormal Values_
 QCABH: 0.000
 Numeric Value:
 1 2 3 4 5 6 ENTR
 7 8 9 0 . CLR

Select "Concen". Enter the number of Dilution. Here you can enter Max 6 Concen, Min 4 Concen

In this screen you can enter both QC Normal (H /L) as well as QC Abnormal (H /L) values.

Name: Mode: FA
 PT: FA_V ESC
 APTT:
 QC: N Incub. Time: 0 SAVE
 Concen
 Normal: N
 Graph: LINEAR
 Normal YES
 NO

Enter Normal Values_
 Low: 0.000
 High: 0.000
 Numeric Value:
 1 2 3 4 5 6 ENTR
 7 8 9 0 . CLR

A

Enter the values of Normal in High / Low range

Name: Mode: FIB
 Unit: mg/dl ESC
 Normal: N
 QC: N Incub. Time: 0 SAVE
 Concen
 Sample Avg: 1
 Graph: PT_TO_PT
 Y vs X: Time vs LOGCONC

Graph Type: PT TO PT ESC
 Y vs X: Time vs LOGCONC
 Type Scale
 LINEAR LogTime vs CONC
 PT TO PT Time vs LOGCONC
 LogitTime vs Log CONC
 Time vs CONC
 LogTime vs Log CON

Name: Mode: FA
 PT: ESC
 APTT:
 QC: N Incub. Time: 0 SAVE
 Concen
 Normal: N
 Graph: LINEAR
 Y vs X: LogTime vs LogCONC

Name: Mode: FA
 PT: ESC
 APTT:
 QC: N Incub. Time: 0 SAVE
 Concen
 Numeric Value:
 1 2 3 4 5 6 ENTR
 7 8 9 0 . CLR

This screen allows you to enter the Incubation time in seconds.

B) Recalling a Saved TEST:

The Programmed / Saved Test can be recalled/selected by List Tests
 When the unit is first turned on, the screen is displayed as shown below

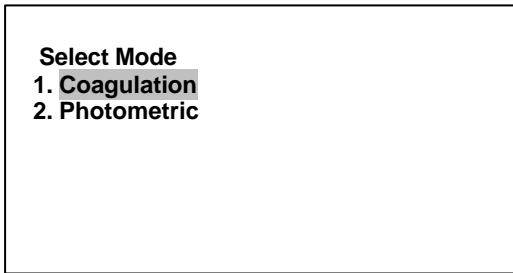

Select Coagulation, Main menu screen is displayed as shown below

Main Menu screen

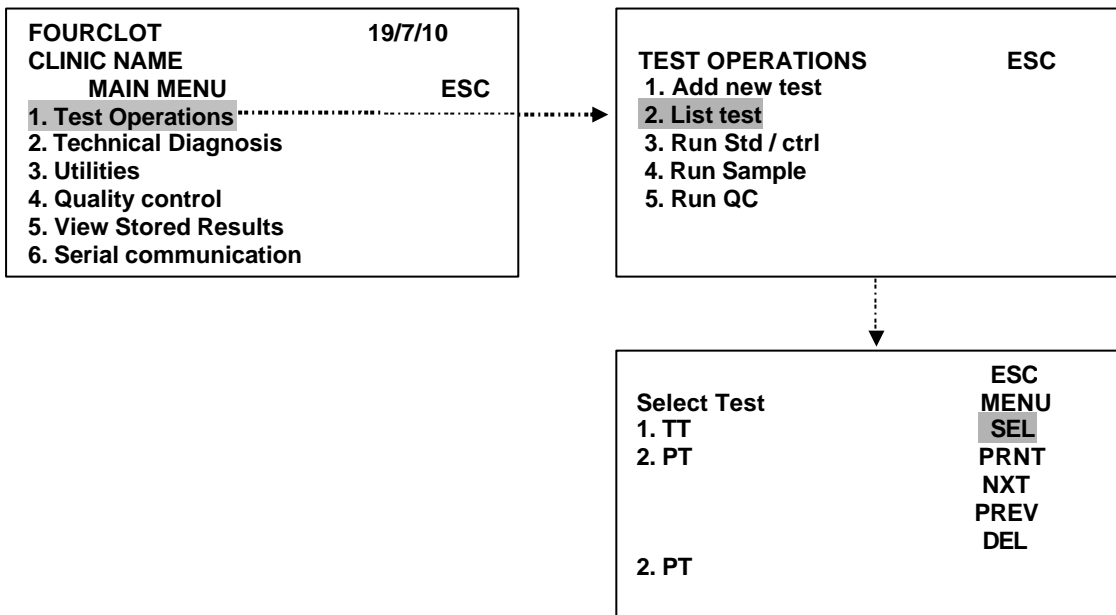

List test displays max. of 10 Tests/ Page .

A "List tests" screen would look like the screen shown above. Touch the test name to select the test. Suppose we have selected the test in PT mode then it will display the screen of PT mode. In this screen you can Edit the test parameters.

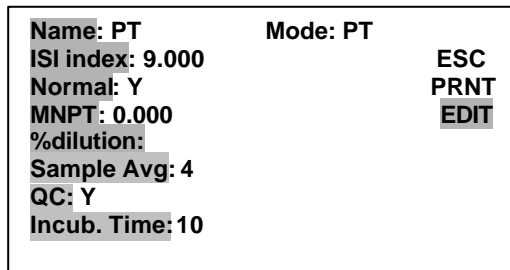

Similarly, you can Edit the test parameters in APTT, TT, FIB, FA mode by recalling the particular test.

C) Running a Saved TEST (Operating the programmed Tests)

1. Run Std / Ctrl
2. Run Sample

1) Run Std / Ctrl :

In case of test with standard/ control without running the standard / control the test sample can not be run.

a. To run the control of PT test:-

When the unit is first turned on, the screen is displayed as shown below:

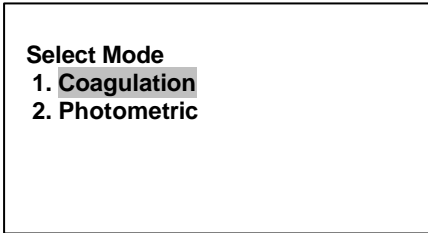

Select Coagulation, Main menu screen is displayed as shown below-
Select Test Operations

Main Menu screen

To run the STD of FIB / FA or Normalization Controls of PT.

Step1: Select Menu TEST OPERATIONS.

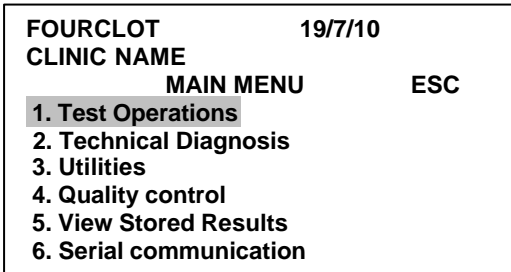

Step 2: Select Run Std / Ctrl.

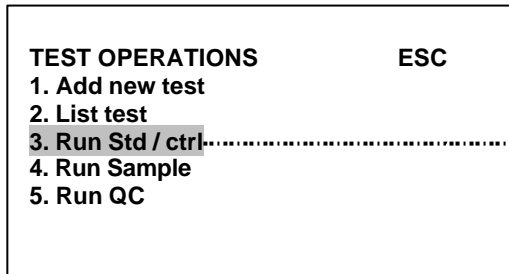

After selecting Run Std / Ctrl menu, screen is displayed to check the channel temperature.

Initially if the channel temperature is 30.43°C then this screen is displayed till Channel temperature attend 37°C. To abort Temperature, Select ESC

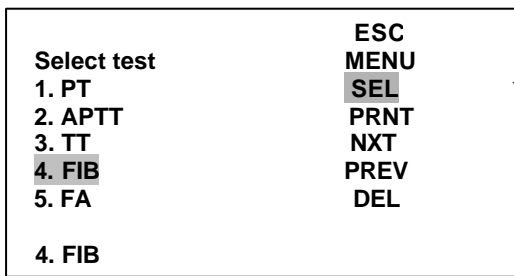
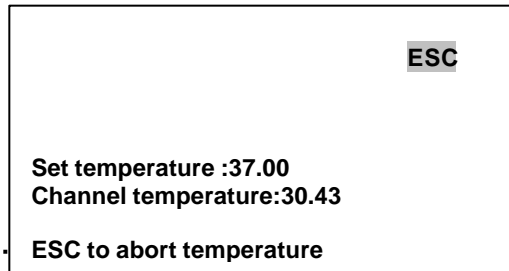

After reaching the temperature or selecting ESC, test mode screen is displayed as shown aside. Select the test mode of which the standard is to be run

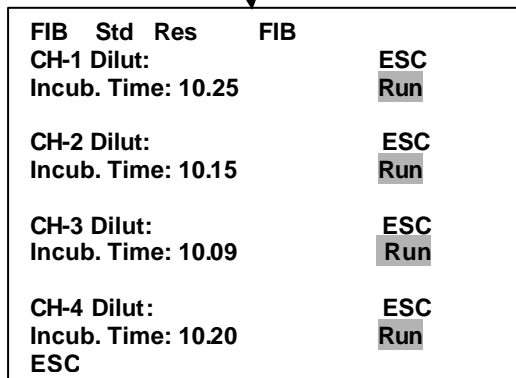

After selecting the particular test, it displays the RUN screen. On selecting the RUN option, it will run the Incubation time if and only if you select Incub. Time in test parameter. Again select RUN option in order to run the standard for the required test.

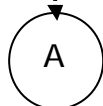

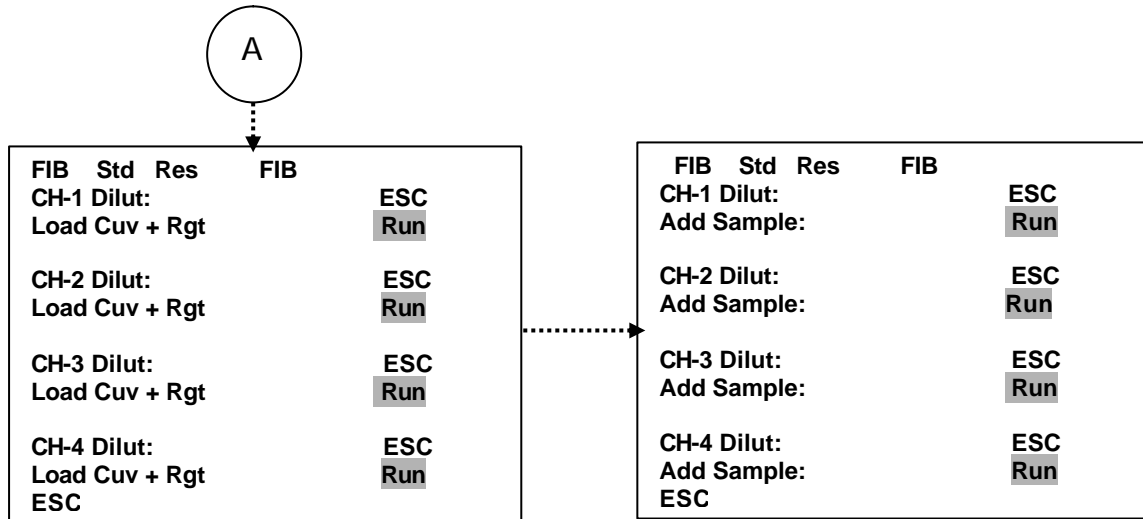

After loading Cuv +Rgt , it will run the standards in FIB mode. Thus you can get the standard values for the test saved in FIB mode. After running the standards you have to run the samples in FIB mode.

2) Run Sample:

When the unit is first turned on, the screen is displayed as shown below

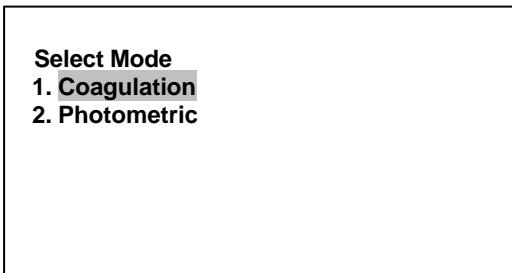

Select Coagulation main menu screen is displayed as shown below
Select Test Operation

Main Menu screen

To run the Sample of added test.

Step 1: Select menu TEST OPERATIONS.

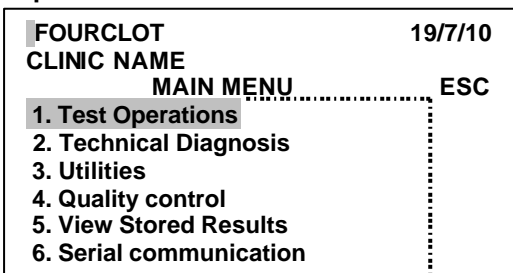

Step 2: Select Run Sample.

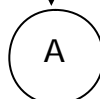
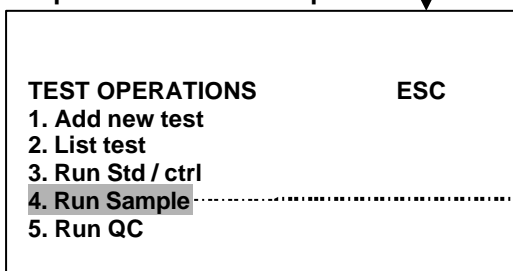

After selecting Run sample menu, screen is displayed to check the channel temperature.

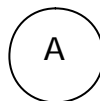

Initially if the channel temperature is 30.43°C then this screen is displayed till Channel temperature attend 37°C. To abort Temperature, Select ESC

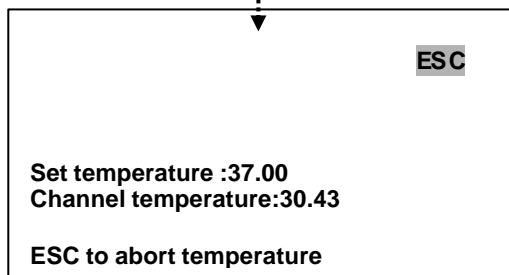

After attending the temperature or Selecting ESC, Program Channels screen is displayed as shown . Select the channel in which you want to run the sample.

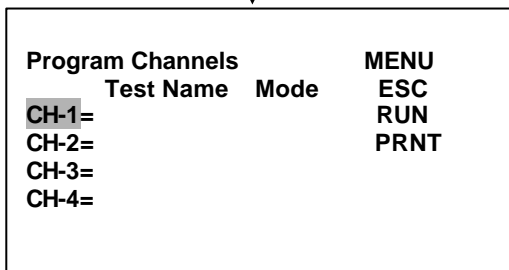

On selecting the channel it will display “Select Test” screen through which we can select the tests whose samples we want to run.

Suppose we have selected test in PT mode whose Sample AVG is 4, then it will assign the samples in all the four channels.

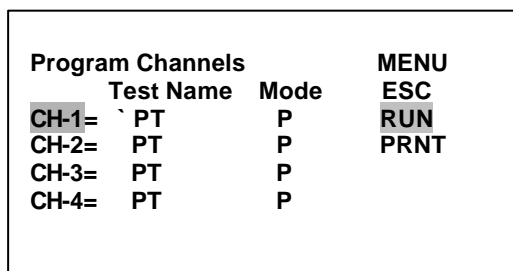

D) List Tests:

List Test screen Displays max. of 10 Tests/ Page .

A "List tests" screen would look like the screen shown below

Select Test	ESC
1 TT	MENU
2 PT	SEL
3 PT_1	PRNT
4 FIB	NXT
5 FA	PREV
	DEL

"ESC ": To escape.
 User can select a saved test by first touching the required TEST NAME on the screen and then touch the "SEL" option to carry out further operation on the test.
 "DEL": Deletes the selected test.
 If the number of tests is more than 10, "NEXT "and "PREV" can be used for browsing through the list pages
 "PRINT": For printing the "LIST TESTS "

Main Menu screen

FOURCLOT 22/7/10	
CLINIC NAME	
MAIN MENU	ESC
1. Test Operations	
2. Technical Diagnosis	
3. Utilities	
4. Quality control	
5. View Stored Results	
6. Serial communication	

TEST OPERATIONS	ESC
1. Add New Test	
2. List Tests	
3. Run STD/ Control	
4. Run Sample	
5. Run QC	

Select Test	ESC
1 TT	MENU
2 PT	SEL
3 PT_1	PRNT
4 FIB	NXT
5 FA	PREV
	DEL
1 TT	

Select Test	ESC
1 TT	MENU
2 PT	SEL
3 PT_1	PRNT
4 FIB	NXT
5 FA	PREV
	DEL

Touch "SEL" to operate the test.
 (The selected test is displayed at the bottom of the screen)

Touch "TT" to select the test.

8.2. TECHNICAL DIAGNOSIS:

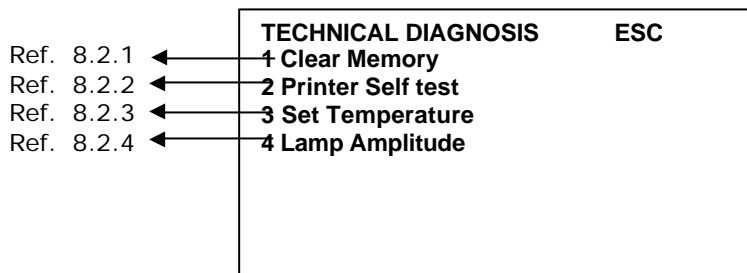

8.2.1. Clear Memory

To clear memory. Tests and results are stored separately.

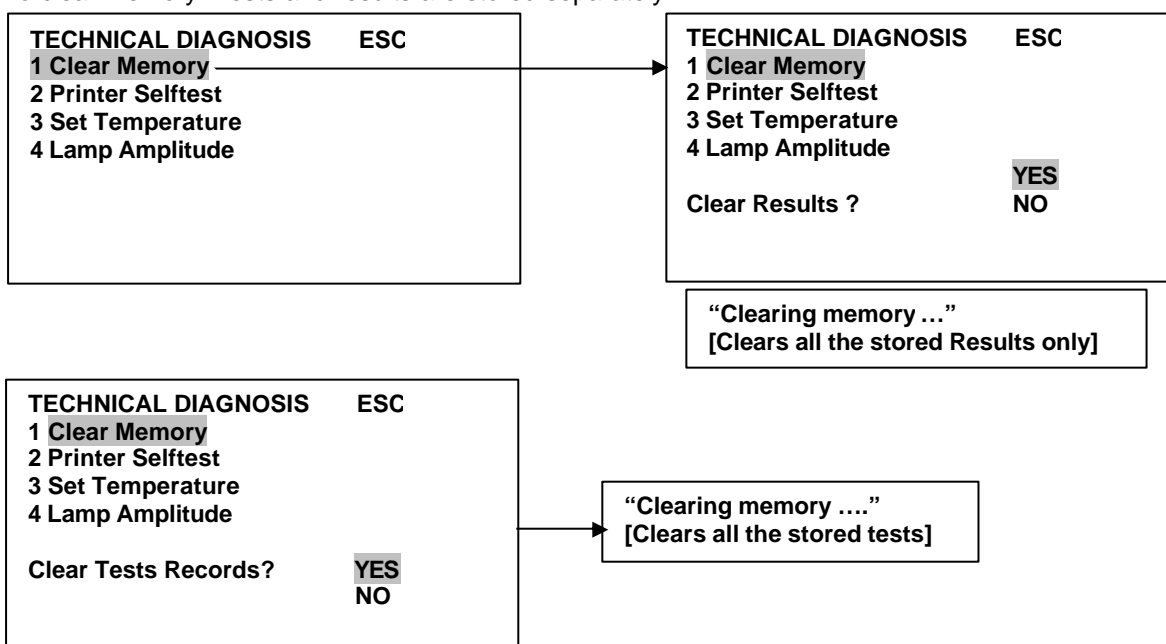

Warning: If you select "YES" option then all the Test Results and Test Records will get deleted.

8.2.2. Temperature Setting

To verify the set temperature.

```

FOURCLOT          22/7/10
CLINIC NAME
  MAIN MENU
1. Test Operations      ESC
2. Technical Diagnosis
3. Utilities
4. Quality control
5. View Stored Results
6. Serial Communication
    
```

```

TECHNICAL DIAGNOSIS  ESC
1 Clear Memory
2 Printer Self Test
3 Set Temperature
4 Lamp Amplitude
    
```

```

Set Channel Temp.      ESC
Temperature=36.86

Ref UP. 785    DOWN.
    
```

```

Temperature Setting  ESC
1 Set Channel Temp.
2 Set Incubation Temp.
    
```

When the required temperature is selected, it displays the cuvette temperature.

```

Set Incubation Temp.  ESC
Temperature=36.46

Ref UP. 785    DOWN.
    
```

8.2.3. Lamp Amplitude

To check lamp amplitude of the filters

```

FOURCLOT          22/7/10
CLINIC NAME
  MAIN MENU
1. Test Operations      ESC
2. Technical Diagnosis
3. Utilities
4. Quality control
5. View Stored Results
6. Serial communications
    
```

```

TECHNICAL DIAGNOSIS  ESC
1 Clear Memory
2 Printer Selftest
3 Set Temperature
4 Lamp Amplitude
    
```

Displays the Lamp Amplitude of all the filters.

Note: The amplitude ideally should be in the range of 1500 to 2400 for all filters.

8.2.4. Printer Self Test

Routine test to check printer. When selected,

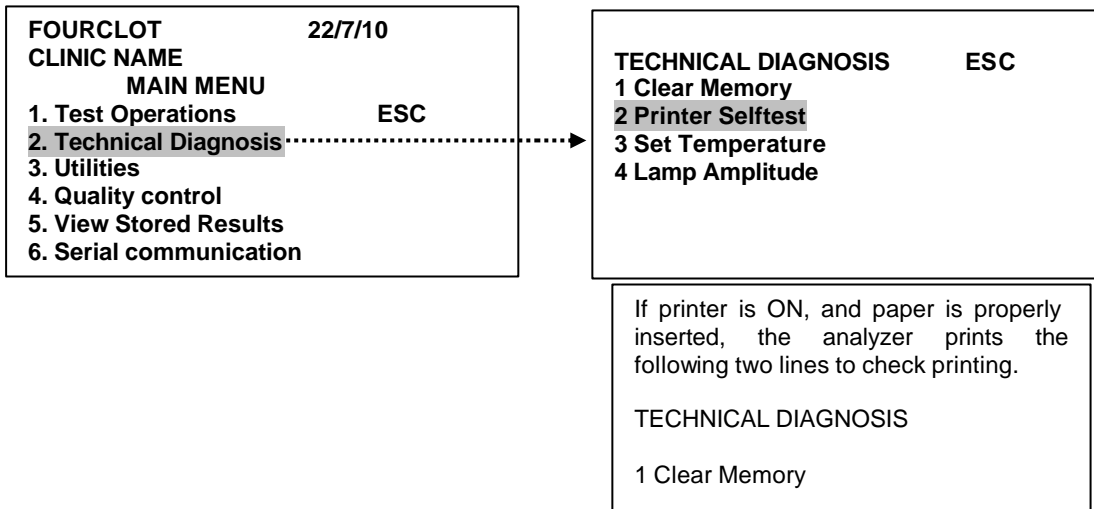

8.3. UTILITIES SCREEN:

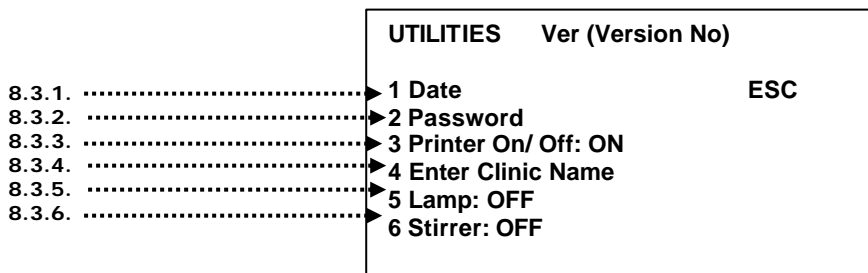

8.3.1. To ENTER/CHANGE Date and Time

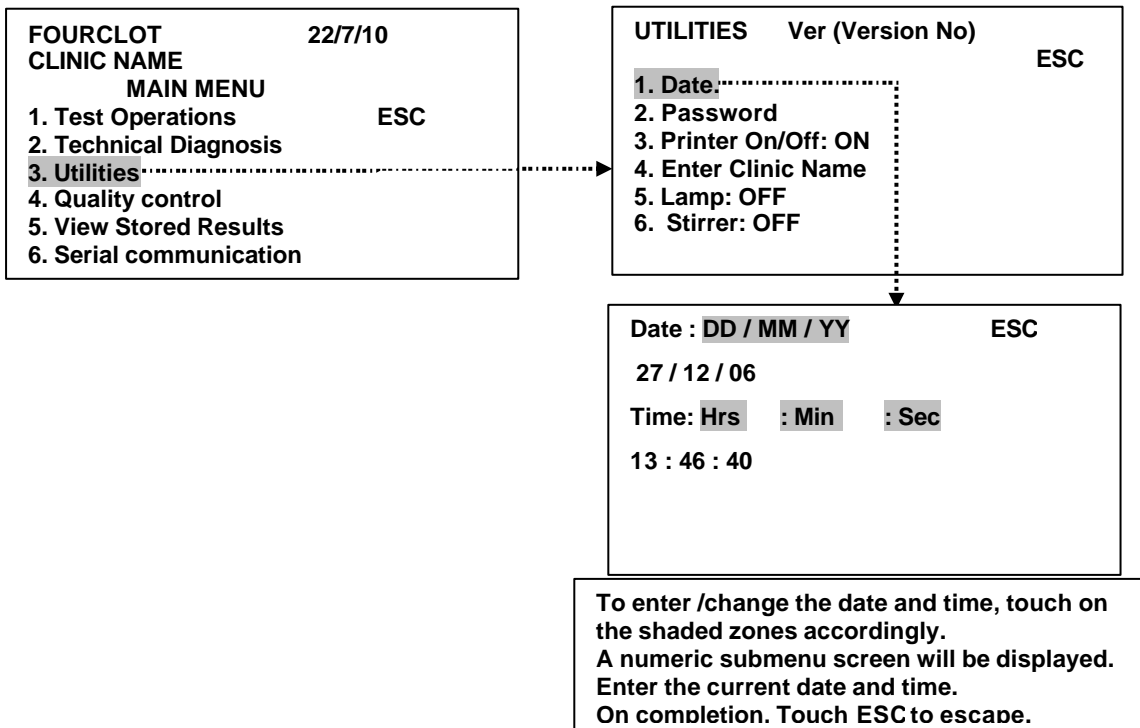

8.3.2. Password Utility:

FOURCLOT 22/7/10
 CLINIC NAME MAIN MENU
 1. Test Operations ESC
 2. Technical Diagnosis
 3. Utilities
 4. Quality control
 5. View Stored Results
 6. Serial communication

UTILITIES Ver (Version No) ESC
 1. Date
 2. Password
 3. Printer On/ Off: ON
 4. Enter Clinic Name
 5. Lamp: OFF
 6. Stirrer: OFF

PASSWORD UTILITY
 ADMIN
 A B C D E F G H
 I J K L M N O P
 Q R S T U V W X ENTR
 Y Z , - + - 1 2 CLR
 3 4 5 6 7 8 9 0

PASSWORD UTILITY ESC
 1. Enable / Disable
 2. Set Password
 3. LOGIN
 4. LOGOUT

To enable password, Enter "PASSWORD"
 Touch ENTR on completion
 (A message" password enabled "will be displayed at the bottom of the screen)

PASSWORD UTILITY
 USER
 A B C D E F G H
 I J K L M N O P
 Q R S T U V W X ENTR
 Y Z , - + - 1 2 CLR
 3 4 5 6 7 8 9 0

To create user, enter required user name For example "DAVID" Touch ENTR on

PASSWORD UTILITY ESC
 1. Enable / Disable
 2. Set Password
 3. LOGIN
 4. LOGOUT

PASSWORD UTILITY
 USER
 A B C D E F G H
 I J K L M N O P
 Q R S T U V W X ENTR
 Y Z , - + - 1 2 CLR
 3 4 5 6 7 8 9 0

To Login/ enable user, enter the name.
 In this example its "DAVID"

8.3.3. To disable or enable the Printer:

It is a toggle to disable or enable the printer.
 (Toggle : Any instruction that works first one way and then the other; it turns something on the first time it is used and then turns it off the next time)

Step 1: Go to "Utilities"

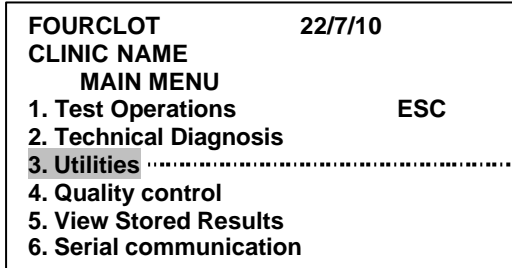

Step 2: Select "Printer On/Off" to enable.

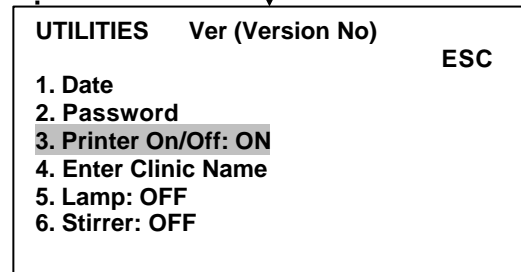
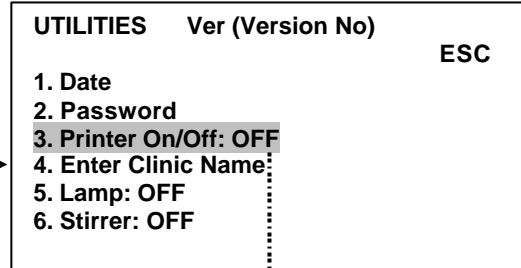

Step 3: Pinter is enabled. To disable the printer select "Printer On/Off"

8.3.4. To Enter Clinic Name:

Step 1: Go to "Utilities"

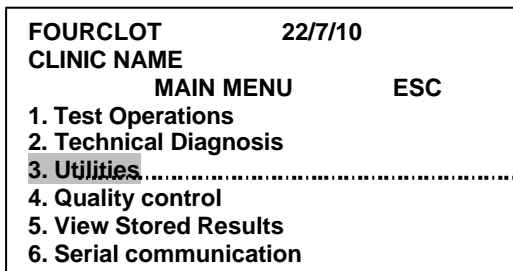

Step 2: Touch "Enter Clinic Name"

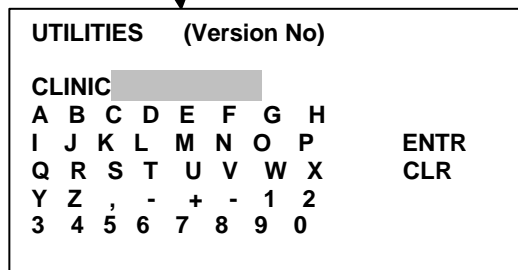
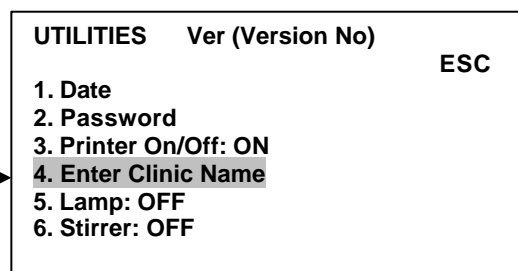

Enter Clinic Name (Max. Up to 19 characters)
 Touch "ENTR", upon completion.
 Touch "CLR", to clear a wrong entry.

8.3.5. Lamp: ON

It is a toggle to switch the lamp ON and OFF only in case of Photometric mode. Whereas in Coagulation mode, the LAMP is always in OFF condition.

(Toggle: any instruction that works first one way and then the other; it turns something on the first time it is used and then turns it off the next time)

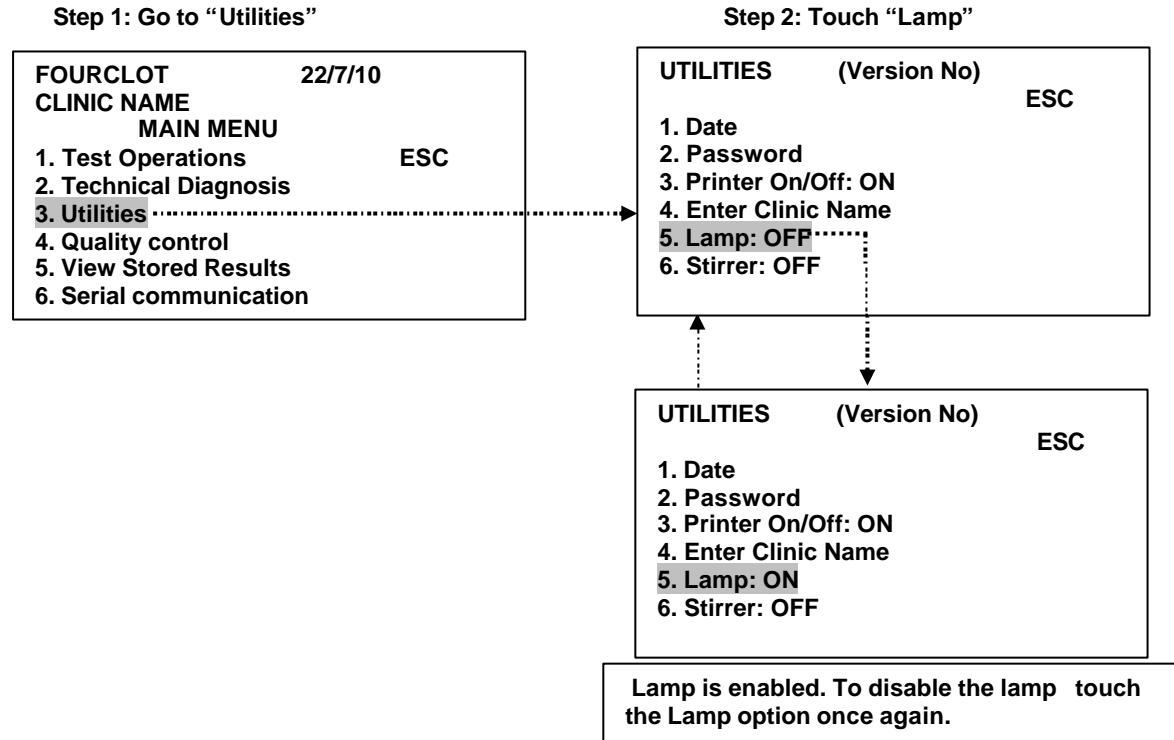

8.3.6. Stirrer: ON

It is a toggle to switch the lamp ON and OFF.

(Toggle: any instruction that works first one way and then the other; it turns something on the first time it is used and then turns it off the next time)

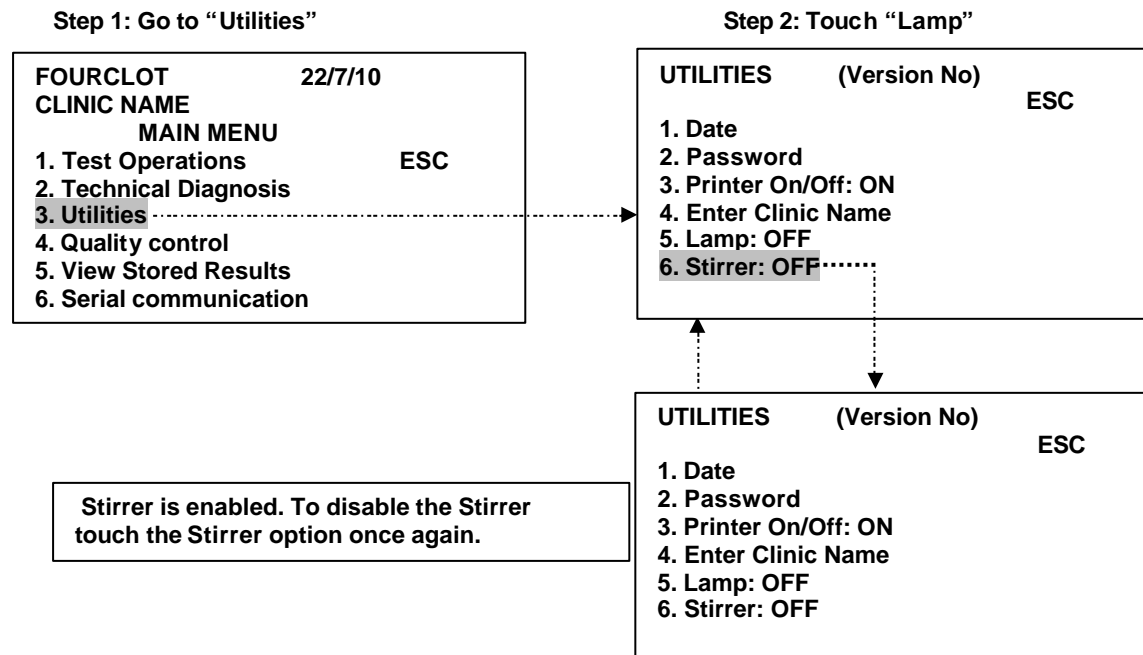

8.4. QUALITY CONTROL:

Quality Control is a process that checks an instrument or testing site to make sure it is reporting accurate results on patients. The reproducibility of a result from a testing site or instrument should fall within a certain range. Control solutions of known values are often times used for checking quality control. An institution may choose how often control solutions are run depending on the accrediting body and test complexity the analyte falls under. Levy Jennings charts are often used identify problems with QC results.

A **levy Jennings** chart is a graph that quality control data is plotted on to give a visual indication whether a laboratory test is working well.

SD Standard Deviation: A measure of variability representing an average distance of the data from the mean. The greater the standard deviation, the greater the difference between the individual determinations and the less the precision of the method.

For example:

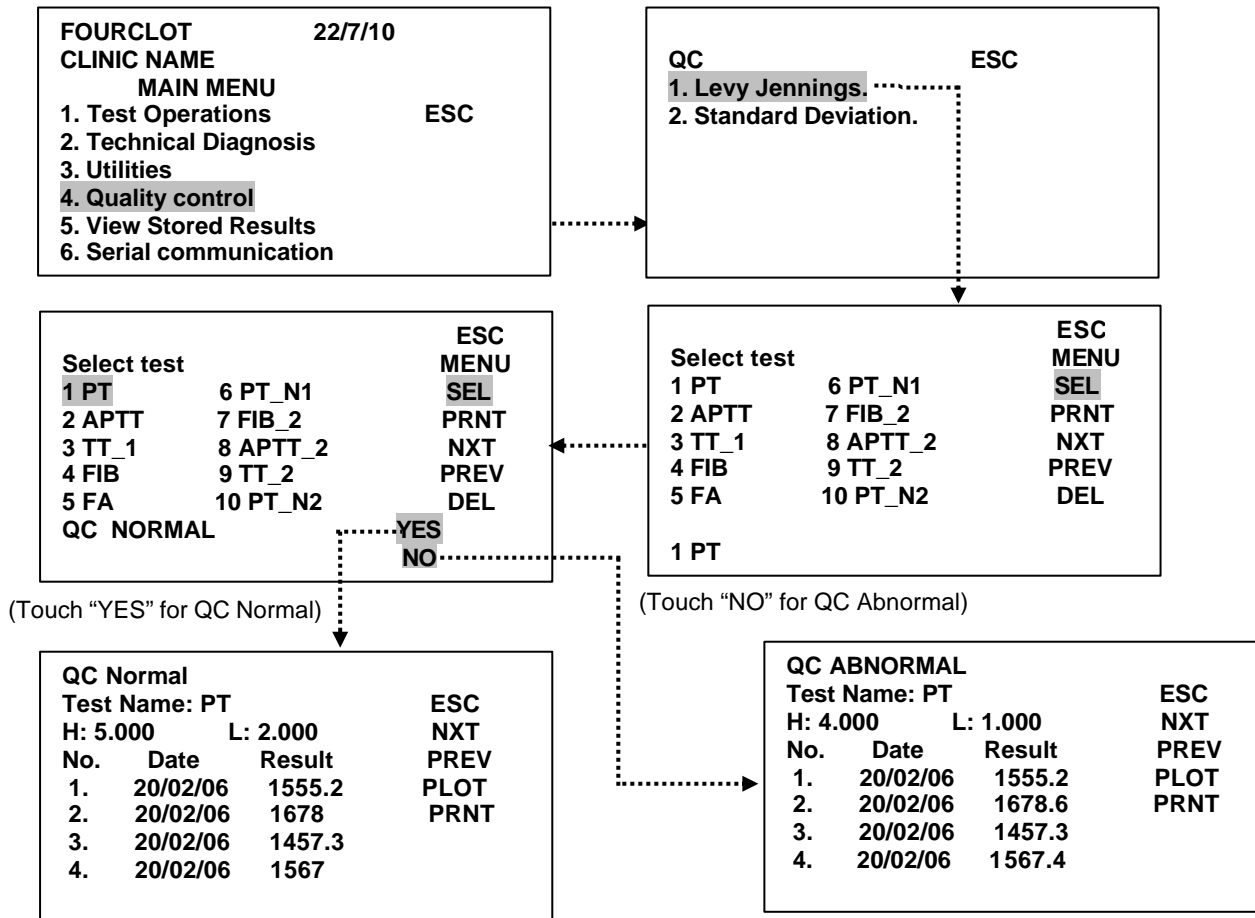

8.5. View Stored Results/ Print Patient Report:

Displays the latest 10 stored tests results.

The system can store 2500 results in its database. The moment a sample is RUN, the result is stored in the system database. The variables stored in the database are as follows

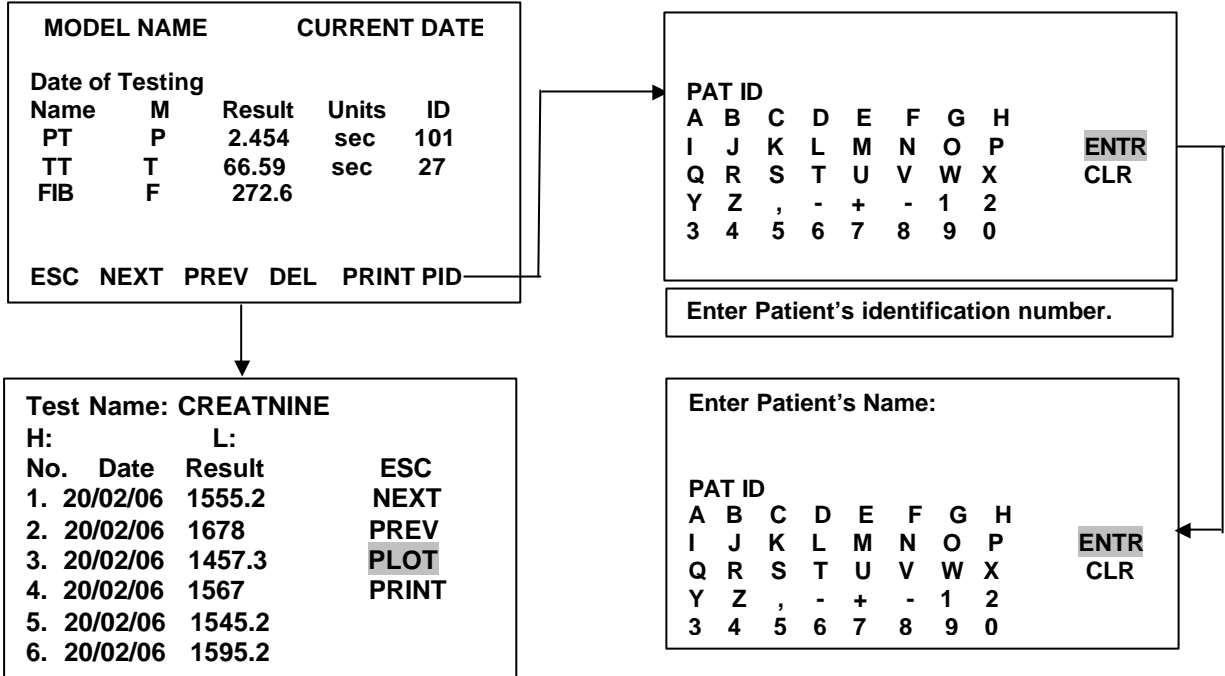

“PRINT”: Prints the Patient report with the patient name and identification number
(Note: The patient’s name and identification number (PID) can be entered up to six places)

“DEL”: To delete the selected result.

M: Mode (2ND Column): A-Absorbance, F-Fixed time, K-Kinetic, E- Endpoint,
D-Differential, R-Ratio

8.6. Serial communication:

The instrument is equipped with an RS232 serial port for PC configuration (user-computer interface.)
A cable is available to link the instrument to PC

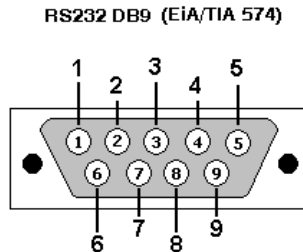

Communication will only start when both ends detect the presence of an active terminal or device.
RS232 port settings in a windows Operating system

PORT SETTINGS

Bits per second : 9600
Data Bits : 8
Parity None : None
Stop Bits : 1
Flow control : None

FOURCLOT 22/7/10
CLINIC NAME
MAIN MENU
1. Test Operations
2. Technical Diagnosis
3. Utilities
4. Quality control
5. View Stored Results
6. **Serial communication**

ESC

SERIAL COMM.

1. **Send Results** ESC

Result YES
NO



9. Programming Modes (PHOTOMETRIC)

9.1. ABSORBANCE

The instrument measures the Blank transmittance and the Sample transmittance, subtracts them and calculates the sample absorbance (**monochromatic mode**). It is possible to repeat the measure with a different wavelength (Filter 2 / secondary filter) and consider the difference between the two measures. (**Bichromatic mode**)

PROGRAMMING / ADDING a NEW TEST

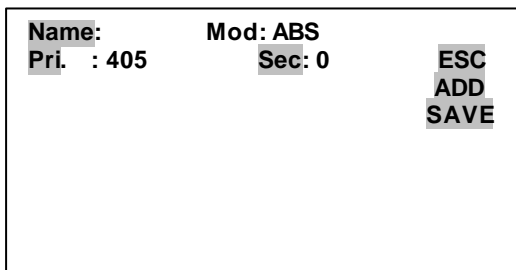

ABSORBANCE Mode screen before programming would look like the above screen

Refer chapter11 for entering the test parameters .On completion, touch “SAVE” to save the programmed test

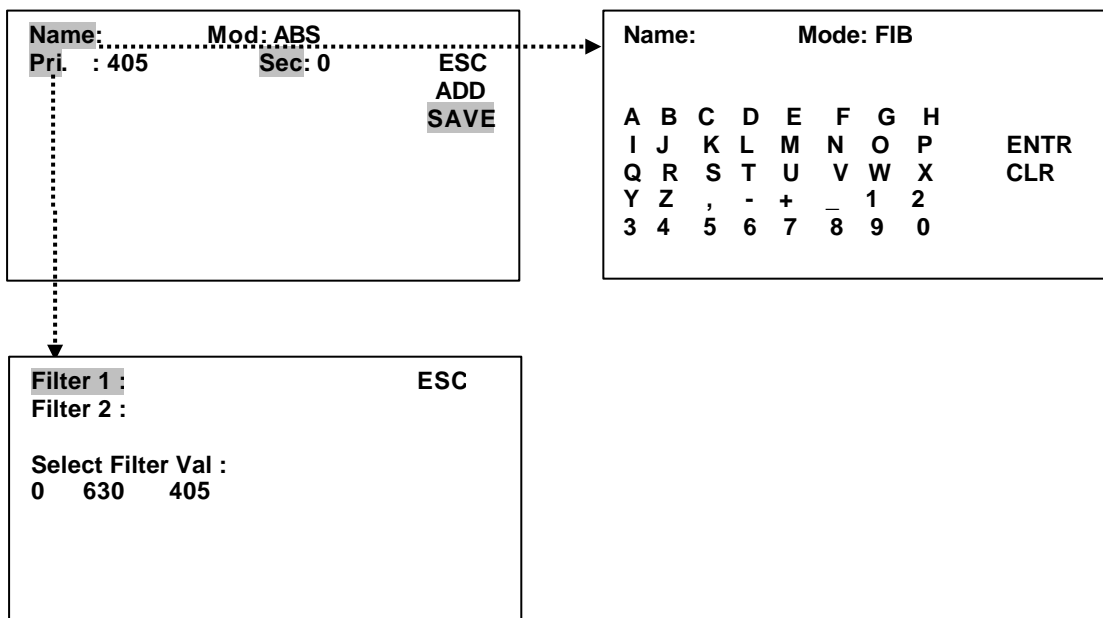

➤ **Recalling /Running (Operating) a pre-programmed test**

For example:

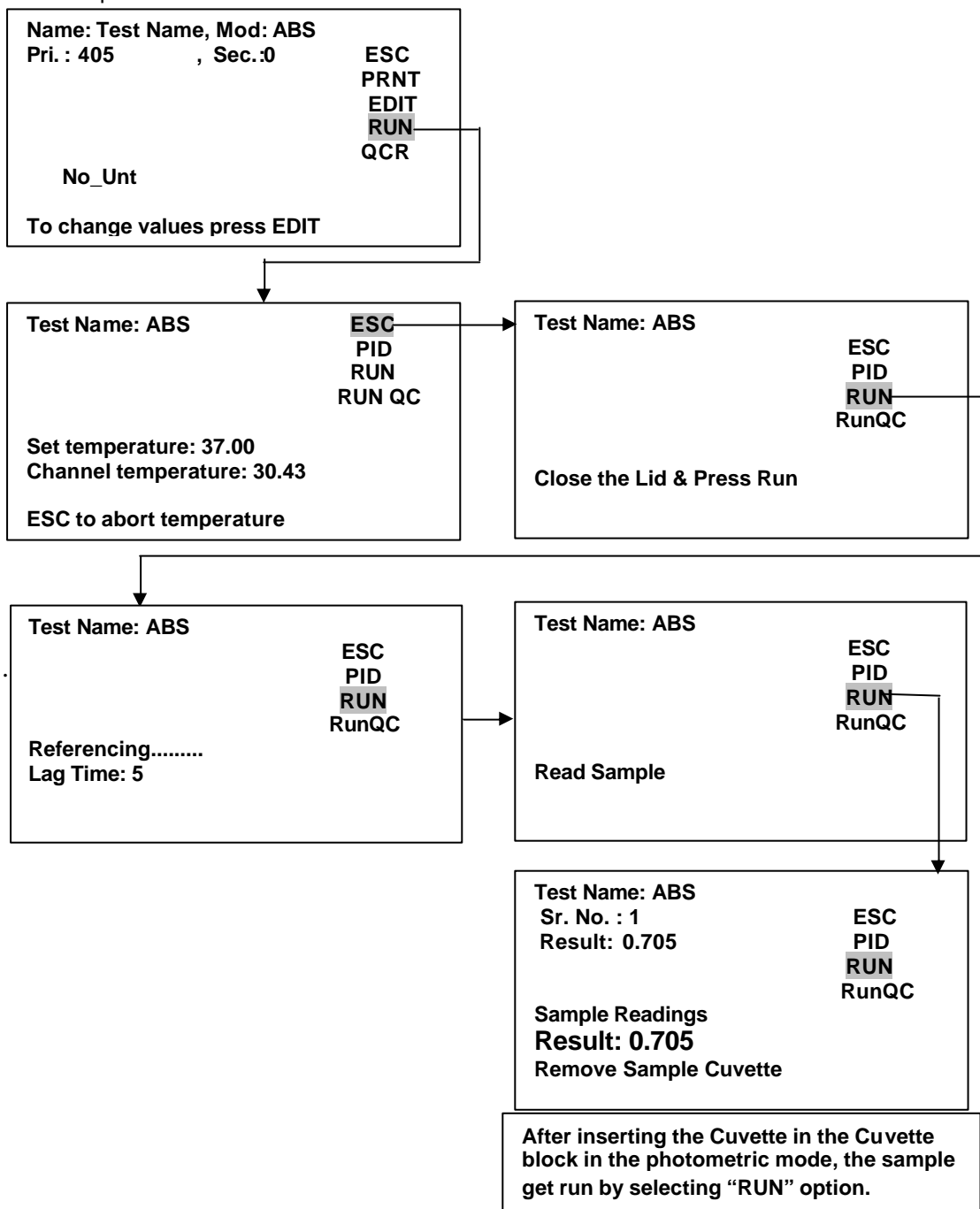

9.2. FIXED TIME

Change in absorbance of sample is taken at programmed time interval and concentration is calculated either from the factor fed by the user or using standard.

PROGRAMMING / ADDING a NEW TEST

```

Name:          Mod: FIX
Pri: 405      ,Sec: 0      ESC
KF: 1.000                    PRNT
Unit: No-Unt   QC: N      EDIT
Lag: 0        ,Read: 0    RUN
Blk: N,       Normal: N   QCR
Std: N,       Factor: 0.000
Limit Set:
    
```

FIXED TIME Mode screen before programming would look like the above screen

Refer chapter11 for entering the test parameters .On completion, touch **"SAVE"** to save the programmed test in memory.

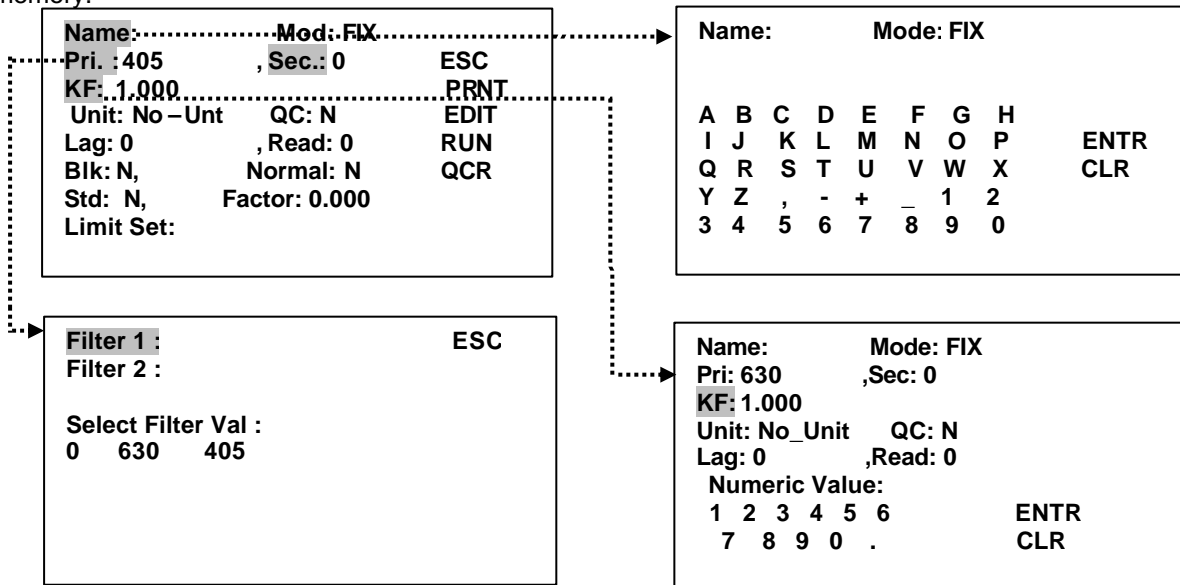

Name: Mode: FIX
 Pri: 630 ,Sec: 0 ESC
 KF: 1.000 ADD
 Unit: No.,Unit.....QC: N.....SAVE
 Lag: 0 ,Read: 0
 Blk: N Normal: N
 Std: N Factor: 1.000
 Limit Set:

UNITS__
 No_ Unt U/ L
 mU/ ml MIL
 U/ml mEq/ L
 mmo/ L Umo/ L
 nmo/ L %
 g/ l mg/ dl
 Ug/ dl g/ dl
 Ug/ ml

Set Times_
 Lag Time: 0
 Read Time: 0
 Numeric Value:
 1 2 3 4 5 6 ESC
 7 8 9 0 . CLR

Name: Mod: FIX
 Pri. : 405 ,Sec.: 0
 KF: 1.000
 Unit: No-Unt QC: N
 Lag: 0 ,Read: 0
 Blk: N, Normal: N
 Std: N, Factor: 0.000
 Blank: YES
 NO

Touch "YES", if you want to select Blank.

Name: Mod: FIX
 Pri. : 405 ,Sec.: 0
 KF: 1.000
 Unit: No-Unt QC: N
 Lag: 0 ,Read: 0
 Blk: N, Normal: N
 Std: N, Factor: 0.000
 Standard YES
 NO

Name: Mod: FIX
 Pri. : 405 ,Sec.: 0
 KF: 1.000
 Unit: No-Unt QC: N
 Lag: 0 ,Read: 0
 Blk: N, Normal: N
 Std: Y, Concen:

Touch "YES", if you want to Run the Standards in Fixed Time mode. Touch "Concen" in order to enter the number of concentrations.

Std Num: 0
 Con1: 25 Del1:
 Con2: 50 Del2:
 Con3: Del3:
 Con4: Del4:
 Con5: Del5:
 Con6: Del6:
 Con7: Del7:
 Numeric Value:
 1 2 3 4 5 6 ENTR
 7 8 9 0 . CLR

Here you have to enter the number of standards, after which you can enter it's concentration.

(Touch "NO" if you want to select "Factor")

Name: Mod: FIX
 Pri. : 405 ,Sec.: 0
 KF: 1.000
 Unit: No-Unt QC: N
 Lag: 0 ,Read: 0
 Blk: N, Normal: N
 Std: N, Factor: 0.000
 Limit Set:

Name: Mod: FIX
 Pri. : 405 ,Sec.: 0
 KF: 1.000
 Unit: No-Unt QC: N
 Lag: 0 ,Read: 0
 Numeric Value:
 1 2 3 4 5 6 ENTR
 7 8 9 0 . CLR

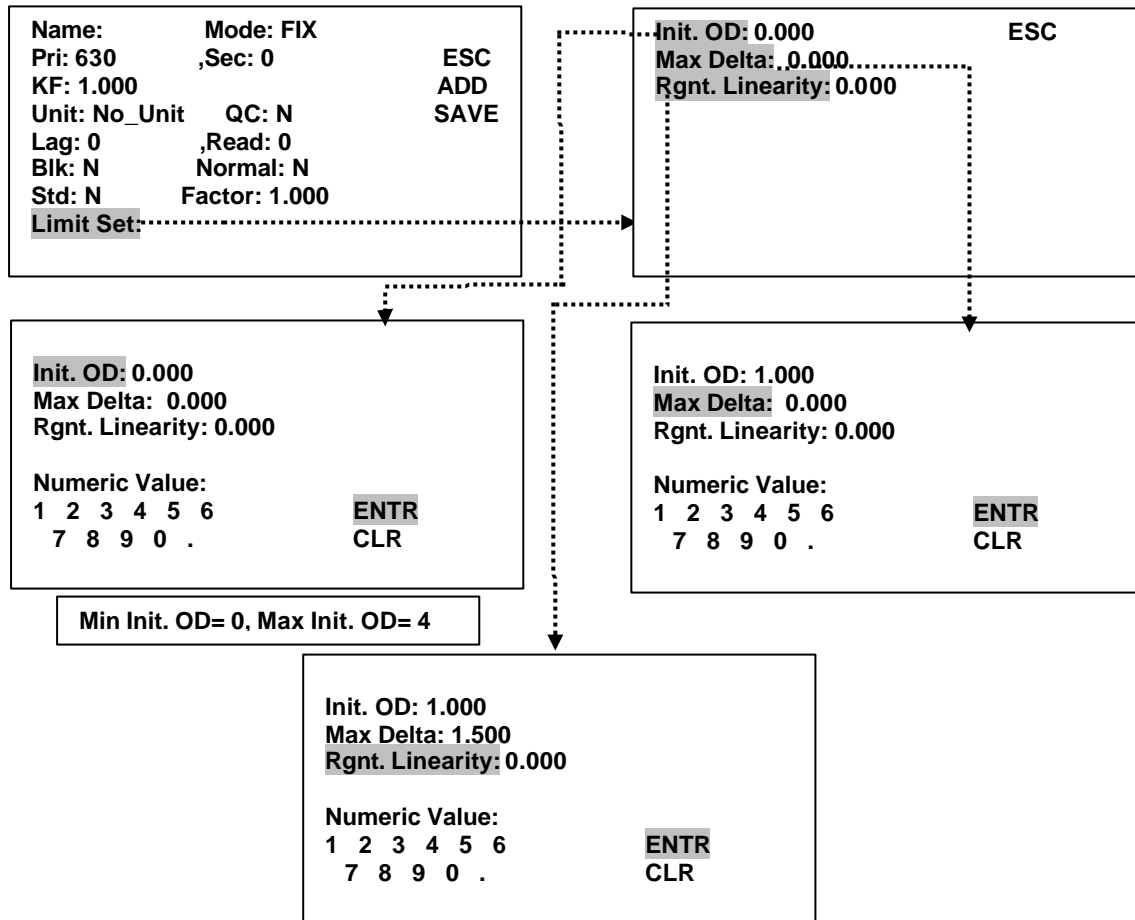

After entering all the parameters in FIXTIME mode, touch the SAVE option present on the screen.

➤ **Recalling /Running (Operating) a pre-programmed test.**

For example: (Running screen of FIXED TIME mode when Factor=1)

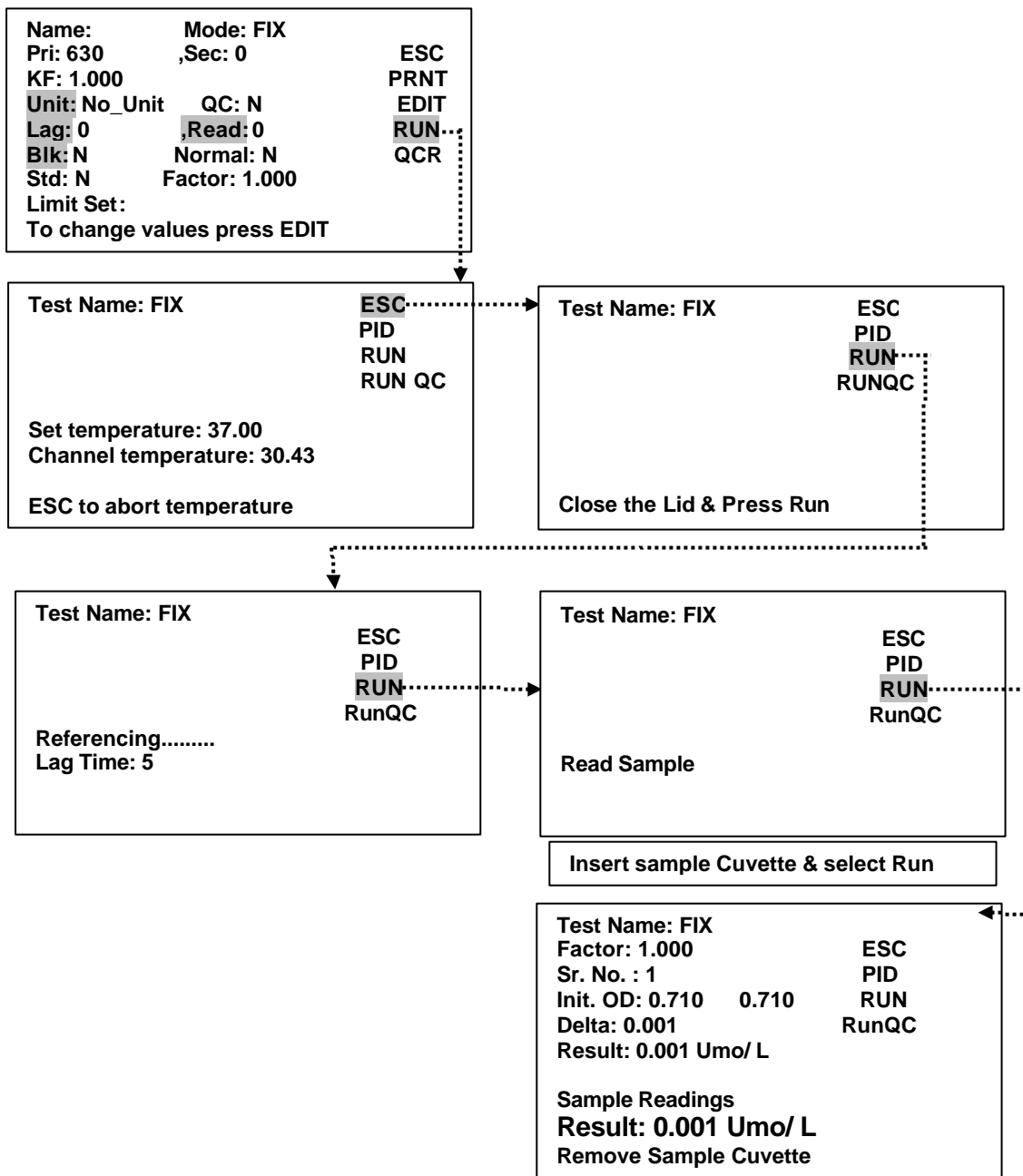

9.3. KINETIC

Multiple readings are taken at set temperature, at regular intervals and change in absorbance per minute is calculated. Concentration is calculated from the factor fed by the user or by using standard.

PROGRAMMING / ADDING a NEW TEST

```

Name:          Mode: KIN
Pri: 630      ,Sec: 0      ESC
KF: 1.000    ,          ADD
Unit: mg/ dl  QC: N       SAVE
Lag: 0       ,Read: 0
Blk: N       Normal: N
Std: N       Factor: 1.000
Limit Set:
    
```

KINETIC Mode screen before programming would look like the above screen

```

Name:          Mode: KIN
Pri: 630      ,Sec: 0      ESC
KF: 1.000    ,          ADD
Unit: mg/ dl  QC: N       SAVE
Lag: 0       ,Read: 0
Blk: N       Normal: N
Std: N       Factor: 1.000
Limit Set:
    
```

```

Name:          Mode: KIN
A B C D E F G H
I J K L M N O P   ENTR
Q R S T U V W X   CLR
Y Z , - + _ 1 2
3 4 5 6 7 8 9 0
    
```

```

Filter 1 :          ESC
Filter 2 :
Select Filter Val :
0 630 405
    
```

```

Name:          Mode: FIX
Pri: 630      ,Sec: 0
KF: 1.000
Unit: No_Unit  QC: N
Lag: 0         ,Read: 0
Numeric Value:
1 2 3 4 5 6   ENTR
7 8 9 0 .     CLR
    
```

Select the Primary & Secondary filters.

```

Name:          Mode: KIN
Pri: 630      ,Sec: 0      ESC
KF: 1.000    ,          ADD
Unit: mg/ dl  QC: N       SAVE
Lag: 0       ,Read: 0
Blk: N       Normal: N
Std: N       Factor: 1.000
Limit Set:
    
```

```

UNITS_
No_ Unt   U/ L
mU/ ml   MIL
U/ml     mEq/ L
mmo/ L   Umo/ L
nmo/ L   %
g/ l     mg/ dl
Ug/ dl   g/ dl
Ug/ ml
    
```

```

Set Times_
Lag Time:0
Read Time:0
Numeric Value:
1 2 3 4 5 6   ESC
7 8 9 0 .     CLR
    
```

```

Name:          Mod: KIN
Pri : 405     ,Sec.: 0
KF: 1.000
Unit: No-Unt  QC: N
Lag: 0        ,Read: 0
Blk: N,       Normal: N
Std: N,       Factor:0.000
Blank:                               YES
                                         NO
    
```

Touch "YES", if you want to select Blank.

Name: Mod: KIN
 Pri.: 405 , Sec.: 0
 KF: 1.000
 Unit: No-Unt QC: N
 Lag: 0 , Read: 0
 Blk: N, Normal: N
 Std: N, Factor: 0.000
 Standard

Name: Mod: KIN
 Pri.: 405 , Sec.: 0
 KF: 1.000
 Unit: No-Unt QC: N
 Lag: 0 , Read: 0
 Blk: N, Normal: N
 Std: Y, Concen:

Touch "YES", if you want to Run the Standards in Fixed Time mode. Touch "Concen" in order to enter the number of concentrations.
 (Touch "NO" if you want to select "Factor")

Std Num: 0
 Con1: 25 D/ M1:
 Con2: 50 D/ M2:
 Con3: D/ M3:
 Con4: D/ M4:
 Con5: D/ M5:
 Con6: D/ M6:
 Con7: D/ M7:
 Numeric Value:
 1 2 3 4 5 6 ENTR
 7 8 9 0 . CLR

Here you have to enter the number of standards, after which you can enter it's concentration.

Name: Mod: KIN
 Pri.: 405 , Sec.: 0
 KF: 1.000
 Unit: No-Unt QC: N
 Lag: 0 , Read: 0
 Blk: N, Normal: N
 Std: Y, Factor: 0.000
 Limit Set:

Name: Mod: KIN
 Pri.: 405 , Sec.: 0
 KF: 1.000
 Unit: No-Unt QC: N
 Lag: 0 , Read: 0
 Numeric Value:
 1 2 3 4 5 6 ENTR
 7 8 9 0 . CLR

Name: Mode: KIN
 Pri: 630 ,Sec: 0 ESC
 KF: 1.000 ADD
 Unit: mg/ dl QC: N SAVE
 Lag: 0 ,Read: 0
 Blk: N Normal: N
 Std: N Factor: 1.000
 Limit Set:

Name: Mode: KIN
 Pri: 630 ,Sec: 0 ESC
 KF: 1.000 ADD
 Unit: mg/ dl QC: N SAVE
 Lag: 0 ,Read: 0
 Blk: N Normal: N
 Std: N Factor: 1.000
 Normal YES
 NO

Enter Normal Values_
 Low: 0.000
 High: 0.000
 Numeric Value:
 1 2 3 4 5 6 ENTR
 7 8 9 0 . CLR

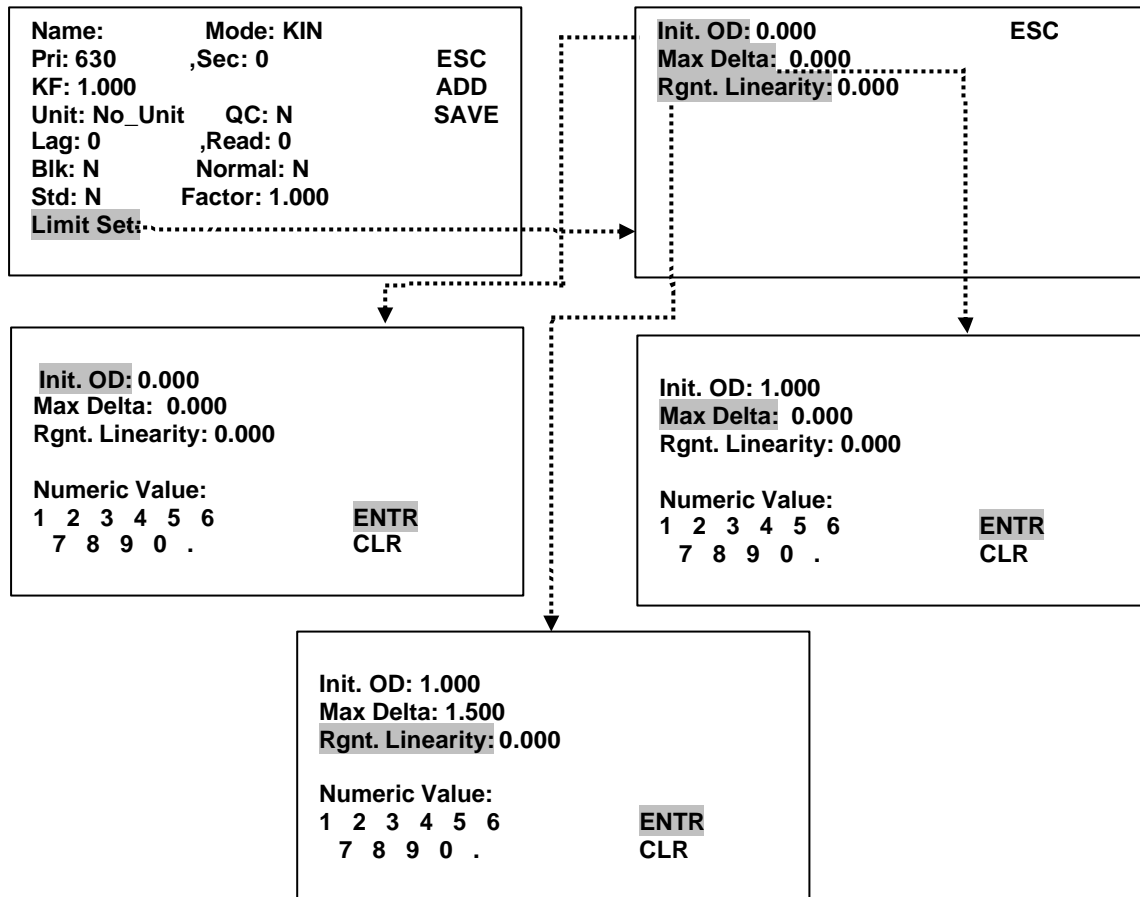

After entering all the parameters in KINETIC mode, touch the SAVE option present on the screen.

➤ **Recalling /Running (Operating) a pre-programmed test**

For example:

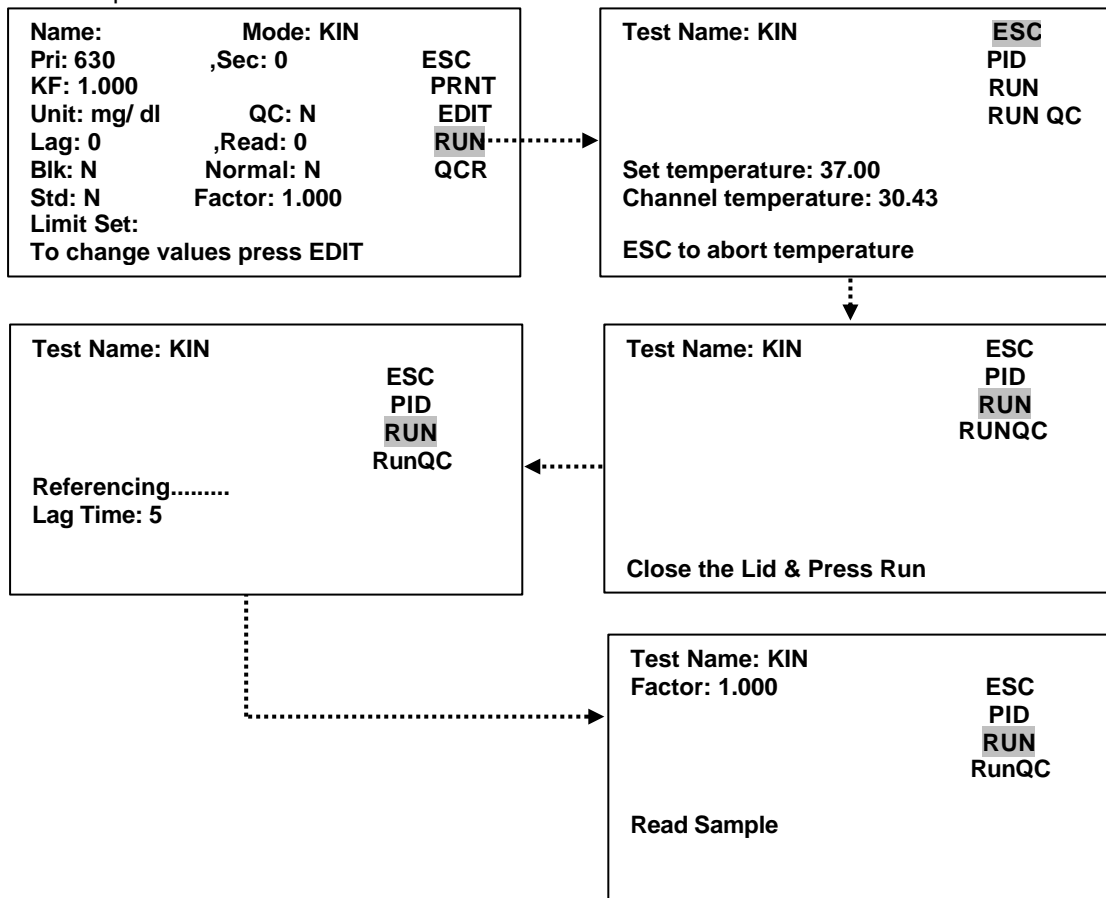

Name: Mod: END
 Pri: 630 ,Sec: 0 ESC
 KF: 1.000 ADD
 Unit: mg/ dl QC: N SAVE
 Lag: 0 ,Read: 0
 Blk: N Normal: N
 Std: N Factor: 1.000
 Limit Set:

QCNormal Values_
 QCNH: 0.000
 QCNL: 0.000
 QCAbnormal Values_
 QCABH: 0.000

 Numeric Value:
 1 2 3 4 5 6 ENTR
 7 8 9 0 . CLR

Name: Mod: END
 Pri : 405 ,Sec.: 0
 KF: 1.000
 Unit: No-Unt QC: N
 Lag: 0 ,Read: 0
 Blk: N, Normal: N
 Std: N, Factor: 0.000
 Standard YES
 NO

Name: Mod: END
 Pri : 405 ,Sec.: 0
 KF: 1.000
 Unit: No-Unt QC: N
 Lag: 0 ,Read: 0
 Blk: N, Normal: N
 Std: Y, Factor: 0.000
 Limit Set:

Touch "NO" if you want to select "Factor"

Name: Mod: END
 Pri : 405 ,Sec.: 0
 KF: 1.000
 Unit: No-Unt QC: N
 Lag: 0 ,Read: 0
 Blk: N, Normal: N
 Std: Y, Concen:

Name: Mod: END
 Pri : 340 ,Sec.: 0
 KF: 1.000
 Unit: No-Unt QC: N
 Lag: 0 ,Read: 0
 Numeric Value:
 1 2 3 4 5 6 ENTR
 7 8 9 0 . CLR

Touch "YES", if you want to Run the Standards in Fixed Time mode. Touch "Concen" in order to enter the number of concentrations.

Std Num: 0
 Con1: 25 Ab1:
 Con2: 50 Ab2:
 Con3: Ab3:
 Con4: Ab4:
 Con5: Ab5:
 Con6: Ab6:
 Con7: Ab7:
 Numeric Value:
 1 2 3 4 5 6 ENTR
 7 8 9 0 . CLR

Here you have to enter the number of standards, after which you can enter it's concentration.

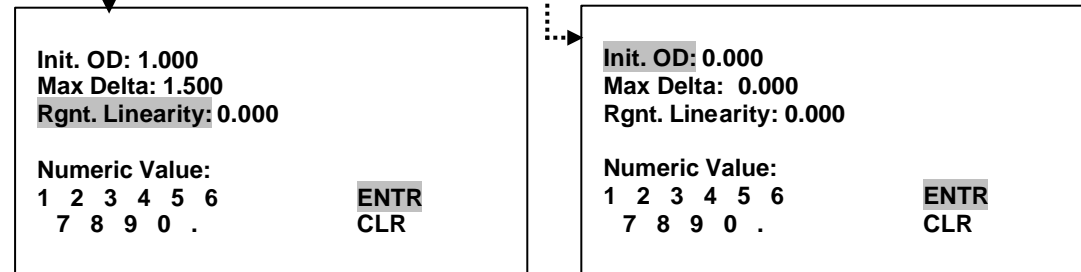
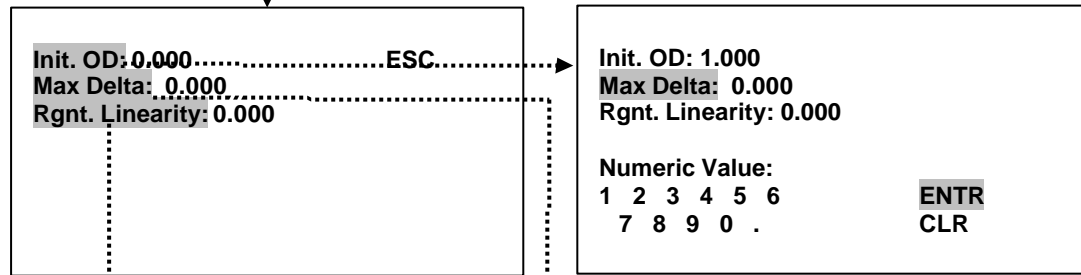
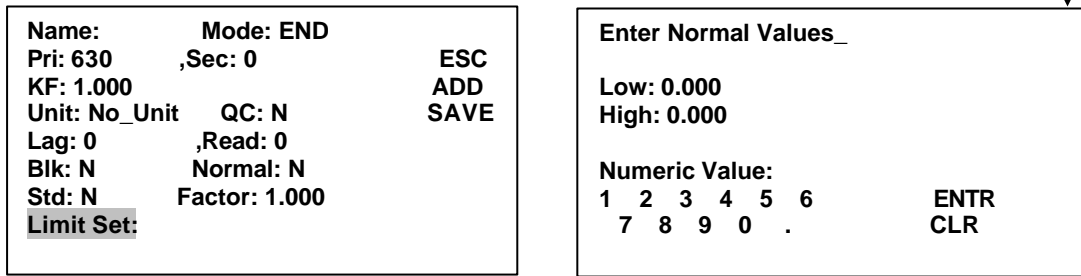
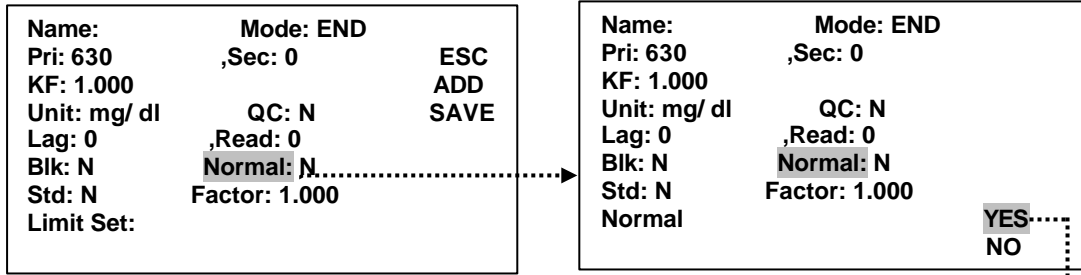

Enter Reagent Linearity in the Numeric screen.
 Touch "ENTR", upon completion.
 Touch "CLR", to clear a wrong entry.

After entering all the parameters in ENDPOINT mode, touch the SAVE option present on the screen.

➤ **Recalling /Running (Operating) a pre-programmed test .**

For example:

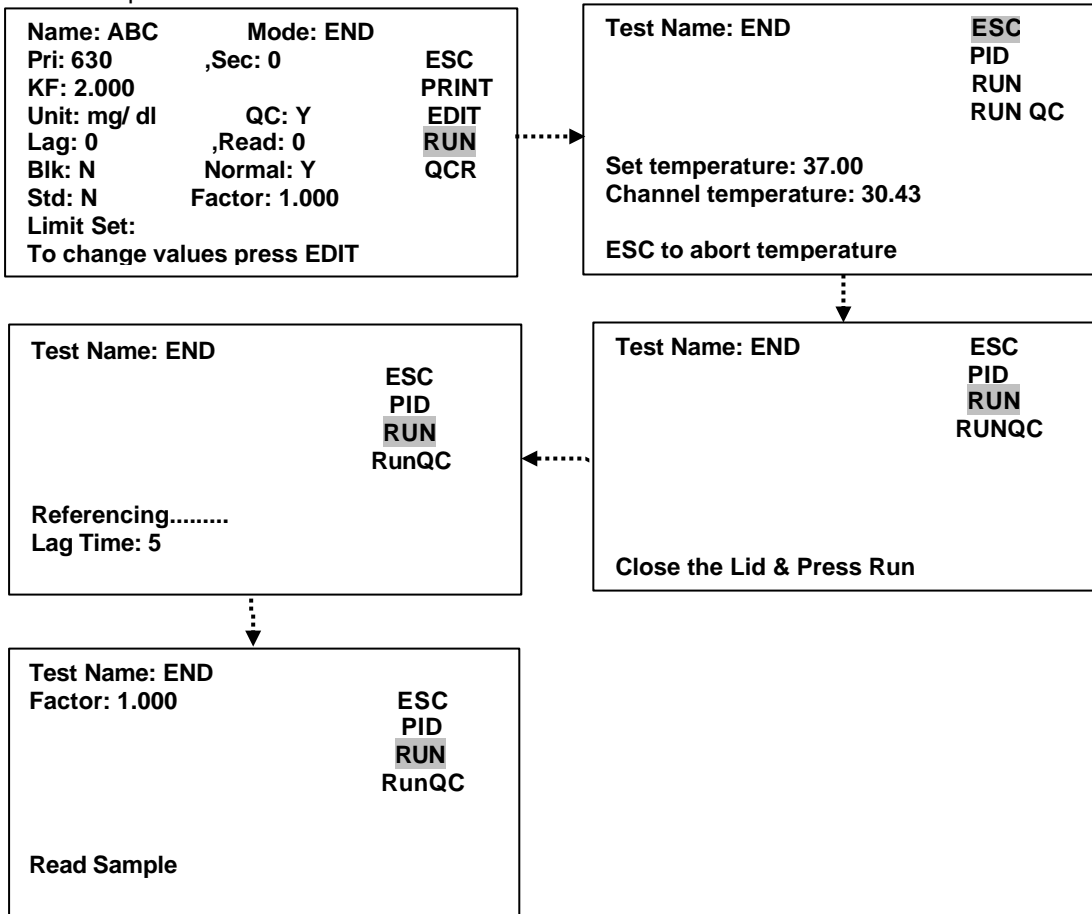

10. Trouble Shooting:

MESSAGES	CAUSE /CORRECTIVE ACTION
Remove Cuvette	This error will come in coagulation mode while referencing. Remove the cuvette.
Invalid Assay	In Multi standard mode if standard are not proper then this error will appear. Check the calibrators and rerun the test.
Memory Full	If Number of saved tests exceeds the memory limit then delete the unwanted tests and save the test.

11. Decontamination

11.1. Decontamination Procedure

If the instrument is to be shipped after being exposed to potentially hazardous material, it should be decontaminated. The following procedure outlines the method of decontaminating the instrument before packaging and shipment.

11.2. Purpose of Decontamination

Decontamination minimizes the risk to all who come in contact with the instrument during shipping, handling, and servicing.

11.3. General Considerations

Any laboratory instrument that has been used for clinical analysis is considered a biohazard and should be decontaminated prior to handling. Intact skin is generally considered an effective barrier against infectious Organisms; however, small abrasions and cuts may not be always be visible. Prophylactic gloves must be worn when handling instruments that have not been decontaminated. Gloved hands should be considered contaminated at all times and must be kept away from eyes, mouth and nose at all times.

Mucous membranes are considered prime entry routes for infectious agents. Wear eye protection and a surgical mask when there is a possibility of aerosols.

Eating and drinking while decontaminating instruments is not advisable.

11.4. Procedure

A solution of .5% Sodium Hypo Chlorite (NaOCL) solution (Bleach) is used. Commercial bleach is 5% NaOCL; household bleach is 3% NaOCL. When using commercial bleach, use a 10:1 mixture; if using household bleach, a 6:1 mixture is required. This is a caustic solution. It is important to wear gloves and eye protection when handling it.

Wipe down the carrier and all exposed surfaces of the unit with the bleach solution. Remove the top shroud of the instrument and wipe down the top surface of the instrument base, as well as the inside of the top shroud.

Reassemble the unit and discard the used gloves and towels.

12. SAFETY CLEARANCE CERTIFICATE

Please complete all information requests on this form prior to returning the instrument to the manufacturer or your local distributor for servicing, repairs or return. Thank you for your co-operation.

Customer _____ Contact _____

Address _____ Position _____

_____ Dept _____

_____ Tel: _____

Country _____ Fax: _____

Post Code _____

Model No. _____ Serial No. _____

Accessories Returned _____

Date of Purchase (if known) _____

Complaint _____

Has the equipment been exposed to any of the following: (*delete as applicable)

a) Blood, body fluids, pathological specimens *YES/NO
If YES, please specify _____

b) Other Biohazard *YES/NO
if YES, Please specify _____
